



T-ONE



Creation
For
Solution

2023 ▶ 2024

CATALOG

ABOUT

Founded in 2007, T-ONE is soon welcoming our 17th anniversary. Witnessing how bicycles changing the world, the cities and people, and noticing how everyday riders are missing from the industry, we redirect our mission.

Cycling is just like human life, it comes with various purposes, leads to different destinations, and should have changeful looks. Hence, T-ONE is now designing bike accessories that not only light up your cycling experience, but also suit to your multi-riding styles. As a bike modern minimalism, we create accessories that are safe, simple and easy-to-use, and speak up your own style.

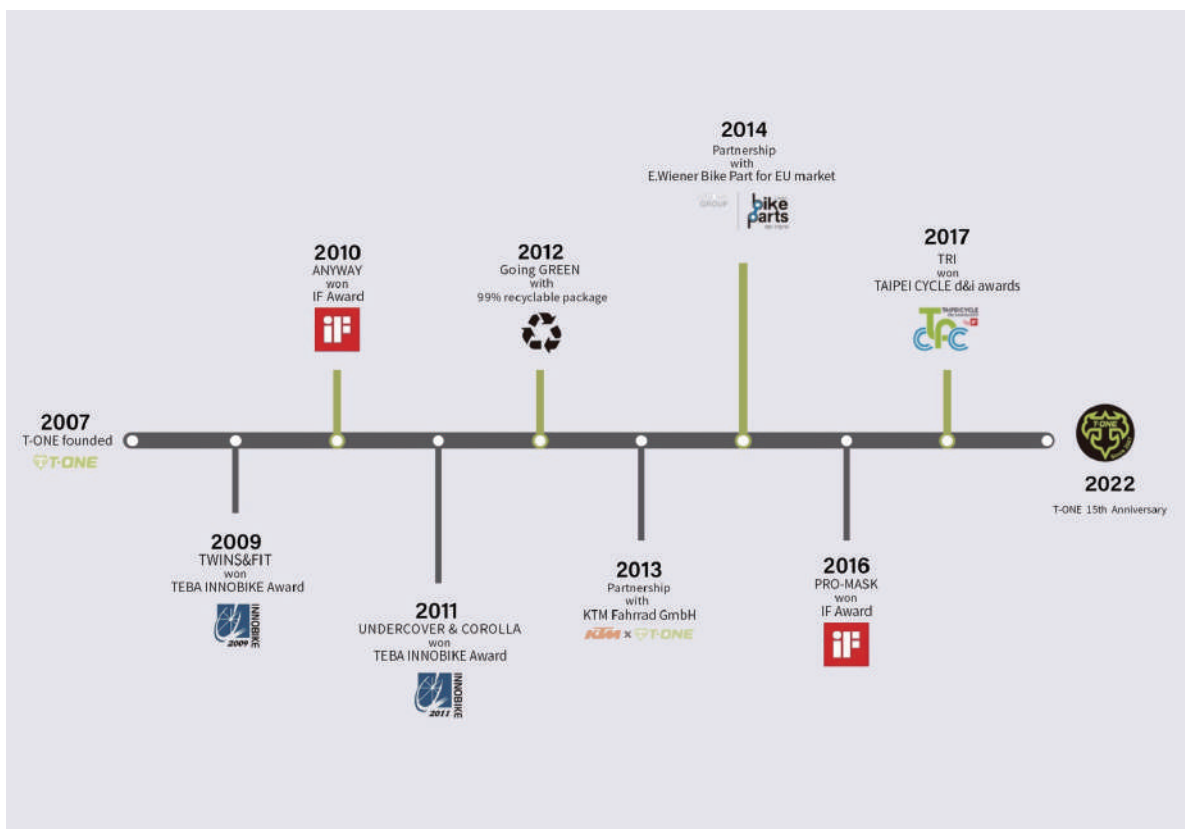

CONTENTS

01 BOTTLE CAGES

15 GRIPS & TAPES

35 MIRRORS

41 BAGS

Saddle Bags/Top Tube Bags/Pannier Bag

49 TOOLS

55 MOUNTING SYSTEM

Front/Stem





SPLASH

BPA-Free Bottle

T-BT01W

Color : White

FIT WELL Patented

Adjustable Bottle Cage

T-BC14G

Color : Grey

BOTTLE CAGES





NEW Patented

FIT WELL

T-BC14



T-BC14L



T-BC14G



T-BC14P

NEW

FIT WELL Patented

Adjustable Bottle Cage

T-BC14

Material : Reinforced plastic

Weight : 95 g

Size Adjustment : 60 to 85mm

Color :



T-BC14P T-BC14G T-BC14L

PRACTICABILITY

All common bottles on the market can be fitted.







Patented



ANYWAY T-BC03

Adjustable Bottle Cage



product design award 2010



This cage is shaped by lightweight pressed aluminum and weighs only 24g. Cyclists, both right-handed and left-handed, can easily adjust the angle by moving the bolt position.

Material : Aluminium

Weight : 24 g

Color :



T-BC03S T-BC03R T-BC03B T-BC03W

Patented

ANYWAY R T-BCN3

Adjustable Bottle Cage



product design award 2010



ANYWAY R , the advanced version ANYWAY that comes with the reflective decal to increase the safety of cycling.

Material : Aluminium

Weight : 24 g

Color :



T-BCN3S T-BCN3R T-BCN3B T-BCN3W



■ ■ Reflective Colors



Reflective



Patented

ORBIT T-BC12



Adjustable Bottle Cage

ORBIT, the plastic version ANYWAY, which not only retains the angle adjustable feature but also provides more flexibility to cage itself due to the material.

Material : Reinforced plastic

Weight : 42 g

Color :



T-BC12R T-BC12B T-BC12W



Instructions For Use

105°

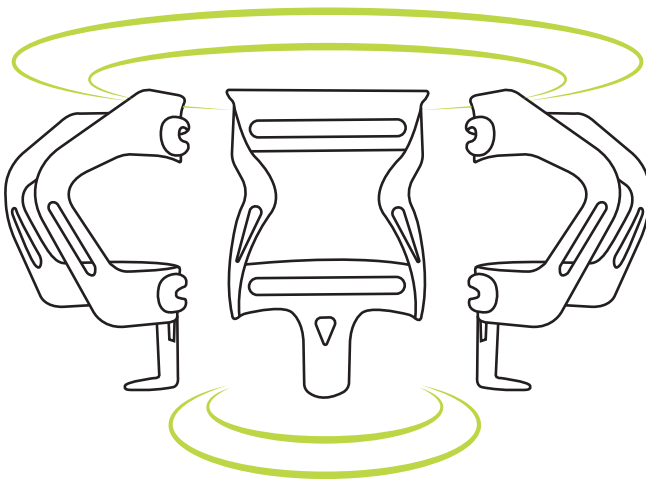



Pull-up  

UP2U Patented
Adjustable Bottle Cage
T-BC10W
Color : White



Patented

UP2U T-BC10

Adjustable Bottle Cage

UP2U provides 2 different cage structures in ONE cage, easily adjust by flipping over the cage upside down.

Material : Reinforced plastic

Weight : 40 g

Color :



T-BC10Y T-BC10O T-BC10W T-BC10T

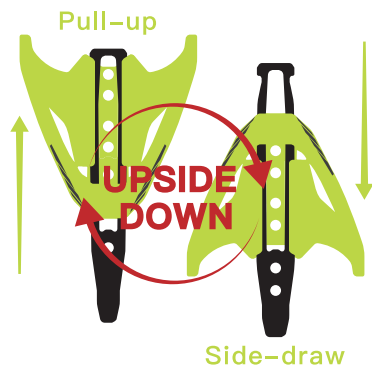



Pull-up



Side-draw



UP2U Patented

Adjustable Bottle Cage

T-BC10Y

Color : Yellow

Side-draw

X-WING

Plastic Bottle Cage

T-BC07B

Color : Black



X-WING T-BC07

Plastic Bottle Cage

Material : Reinforced plastic

Weight : 47 g

Color :



T-BC07N

T-BC07R

T-BC07B

T-BC07W



T-BC07Y

T-BC07O

T-BC07B

T-BC07T



X-WING D T-BCD7

Plastic Bottle Cage

Material : Reinforced plastic

Weight : 50 g

Color :



T-BCD7R



T-BCD7B



T-BCD7W



RAY T-BC13

Plastic Bottle Cage

Material : Reinforced plastic

Weight : 35 g

Color :



T-BC13N



T-BC13R



T-BC13B



T-BC13T



T-BC13W



Matt Surface

Shiny Surface



COROLLA T-BC06

Plastic Bottle Cage

COROLLA adapts the water bottle from 64mm to 74mm in diameter.

Material : Reinforced plastic

Weight : 45 g

Color :



T-BC06B T-BC06W

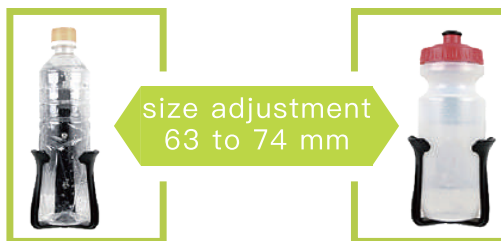

Patented

UPNDOWN T-BC09

Adjustable Bottle Cage

5 different combinations in height position, ranging up to 30mm.

Material : Reinforced plastic

Weight : 44 g

Color :



T-BC09N T-BC09R T-BC09B T-BC09W



▲ Adjusting Range up to 30mm

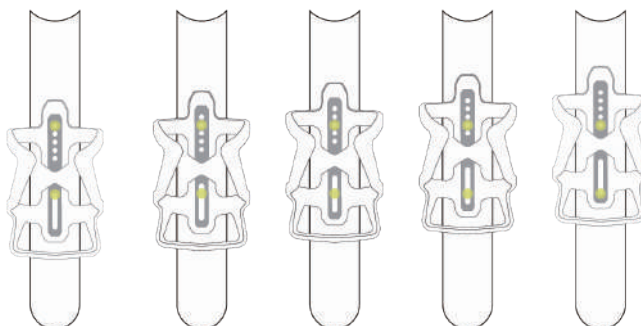



FIX T-BC08

Plastic Bottle Cage

Material : Reinforced plastic

Weight : 38 g

Color :



T-BC08P T-BC08R T-BC08B T-BC08W



T-BC08T



Patented

COBRA T-BC11

Carbon Bottle Cage

Material : Carbon fiber

Weight : 20 g

Color :



T-BC11Y T-BC11R T-BC11M





UP2U Patented

Adjustable Bottle Cage

T-BC10T

Color : Transparent

X-WING T-BC07

Plastic Bottle Cage

Material : Reinforced plastic

Weight : 47 g

Color : Transparent

**Patented****UP2U** T-BC10

Adjustable Bottle Cage

Material : Reinforced plastic

Weight : 40 g

Color : Transparent

**RAY** T-BC13

Plastic Bottle Cage

Material : Reinforced plastic

Weight : 35 g

Color : Transparent

Patented

DIAMOND PLUS

Adjustable length from
94mm to 114mm

T-GP61L

Color : Blue



GRIPS
&
TAPES



AERO

Comfort Grip

T-GP53B

Color : Black

SPLASH

BPA-Free Bottle

T-BT01W

Color : White

FIT WELL Patented

Adjustable Bottle Cage

T-BC14L

Color : Blue



Patented

DIAMOND T-GP60

Adjustable Grip

Variant : Double Lock Ring Grip

Material : TPR / Plastic Core / Aluminum Clamp

Weight : 148 g / pair

Length : 94 \ 104 \ 114 mm....

Color :



T-GP60B T-GP60R T-GP60L

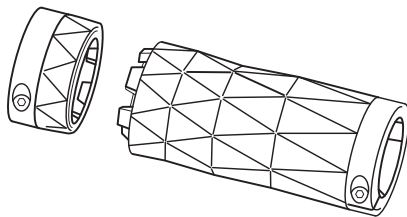

▲ basic length 94 mm

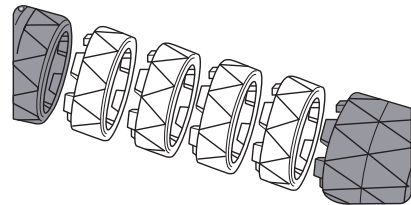

▲ 10 mm spacers x4

Patented

DIAMOND PLUS T-GP61

Adjustable Grip

Variant : Double Lock Ring Grip

Material : TPR / Plastic Core / Aluminum Clamp

Weight : 182 g / pair

Length : 94 \ 104 \ 114 mm....

Color :



T-GP61L T-GP61R T-GP61B







AERO

Comfort Grip

T-GP53B

Color : Black



AERO

Comfort Grip

T-GP53 / 54 / 55 / 56 / 57 / 58 / 59



01



02



03



04



05



01 x 2T-GP53 (130mm x 2)

Variant : Double Lock Ring Grip

Material : TPR / Plastic Core /
Aluminum Lock Ring

Weight : 140 g / pair

Color :

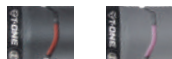

T-GP53B T-GP53G

02 x 2T-GP54 (130mm x 2)

Variant : Single Lock Ring Grip

Material : TPR / Plastic Core /
Aluminum Lock Ring

Weight : 146 g / pair

Color :



T-GP54B T-GP54G

03 x 2T-GP55 (90mm x 2)

Variant : Single Lock Ring Grip

Material : TPR / Plastic Core /
Aluminum Lock Ring

Weight : 102 g / pair

Color :



T-GP55B T-GP55G

02 + 03T-GP56 (130mm + 90mm)

Variant : Single Lock Ring Grip

Material : TPR / Plastic Core /
Aluminum Lock Ring

Weight : 115 g / pair

Color :



T-GP56B T-GP56G

05 x 2T-GP58 (90mm x 2)

Variant : One Piece Grip

Material : TPR

Weight : 78 g / pair

Color :



T-GP58B

04 + 05T-GP59 (130mm + 90mm)

Variant : One Piece Grip

Material : TPR

Weight : 111 g / pair

Color :



T-GP59B

04 x 2T-GP57 (130mm x 2)

Variant : One Piece Grip

Material : TPR

Weight : 144 g / pair

Color :



T-GP57B



EZ
 Comfort Grip
 T-GP16
 Color : Black

EZ

Comfort Grip

T-GP14 / 15 / 16



T-GP14

Variant : Double Lock Ring Grip
Material : TPR / Plastic Core / Aluminum Lock Ring
Weight : 155 g / pair
Length : 130 mm
Color :



T-GP14B T-GP14G



T-GP15

T-GP15A

T-GP15 / T-GP15A

Variant : Double Lock Ring Grip / Single Lock Ring Grip
Material : TPR / Plastic Core / Aluminum Lock Ring
Weight : 155 / 146 g / pair
Length : 130 mm
Color :



T-GP15B T-GP15A



T-GP16

Variant : One Piece Grip
Material : TPR
Weight : 146 g / pair
Length : 130 mm
Color :



T-GP16



01



02



03



04



05

MOVE

Comfort Grip

T-GP20 / 21 / 22 / 23 / 24 / 25

01 x 2

T-GP20 (130mm x 2)

Variant : Double Lock Ring Grip

Material : TPR / Plastic Core / Aluminum Lock Ring

Weight : 98 g / pair

Color :



T-GP20W

02 x 2

T-GP21 (130mm x 2)

Variant : Single Lock Ring Grip

Material : TPR / Plastic Core / Aluminum Lock Ring

Weight : 94 g / pair

Color :



T-GP21G

03 x 2

T-GP22 (130mm x 2)

Variant : One Piece Grip

Material : TPR

Weight : 80 g / pair

Color :



T-GP22B

02 + 04

T-GP23 (130mm + 90mm)

Variant : Single Lock Ring Grip

Material : TPR / Plastic Core / Aluminum Lock Ring

Weight : 98 g / pair

Color :



T-GP23G

03 + 05

T-GP24 (130mm + 90mm)

Variant : One Piece Grip

Material : TPR

Weight : 94 g / pair

Color :



T-GP24B

04 x 2

T-GP25 (90mm x 2)

Variant : Single Lock Ring Grip

Material : TPR / Plastic Core / Aluminum Lock Ring

Weight : 80 g / pair

Color :



T-GP25G



ZAHA

Stylish Grip

T-GP69

Color : Black

ZAHA

Stylish Grip

T-GP69 / 70 / 71



T-GP69

Variant : Double Lock Ring Grip

Material : TPR / Plastic Core / Aluminum Lock Ring

Weight : 120.3 g / pair

Length : 130 mm



T-GP70

Variant : Single Lock Ring Grip

Material : TPR / Plastic Core / Aluminum Lock Ring

Weight : 109.7 g / pair

Length : 130 mm



T-GP71

Variant : One Piece Grip

Material : TPR

Weight : 123 g / pair

Length : 130 mm

ZAHA PLUS

Comfort Grip

T-GP72 / 73 / 74



T-GP72

Variant : Double Lock Ring Grip

Material : TPR / Plastic Core / Aluminum Lock Ring

Weight : 153.3 g / pair

Length : 130 mm



T-GP73

Variant : Single Lock Ring Grip

Material : TPR / Plastic Core / Aluminum Lock Ring

Weight : 141.7 g / pair

Length : 130 mm



T-GP74

Variant : One Piece Grip

Material : TPR

Weight : 154.5 g / pair

Length : 130 mm



01



02



03



04



05



RIPPLE

Comfort Grip

T-GP62 / 63 / 64 / 65 / 66 / 67 / 68

02 x 2

T-GP63 (130mm x 2)

Variant : Single Lock Ring Grip

Material : TPR / Plastic Core / Aluminum Lock Ring

Weight : 166 g / pair

Color :



T-GP63G T-GP63N

03 x 2

T-GP64 (90mm x 2)

Variant : Single Lock Ring Grip

Material : TPR / Plastic Core / Aluminum Lock Ring

Weight : 132 g / pair

Color :



T-GP64G T-GP64N

02 + 03

T-GP65 (130 mm + 90 mm)

Variant : Single Lock Ring Grip

Material : TPR / Plastic Core / Aluminum Lock Ring

Weight : 149 g / pair

Color :



T-GP65G T-GP65N

04 x 2

T-GP66 (130mm x 2)

Variant : One Piece Grip

Material : TPR

Weight : 176 g / pair

Color :



T-GP66L T-GP66G

05 x 2

T-GP67 (90mm x 2)

Variant : One Piece Grip

Material : TPR

Weight : 136 g / pair

Color :



T-GP67L T-GP67G

04 + 05

T-GP68 (130mm + 90 mm)

Variant : One Piece Grip

Material : TPR

Weight : 156 g / pair

Color :



T-GP68L T-GP68G

01 x 2

T-GP62 (130mm x 2)

Variant : Double Lock Ring Grip

Material : TPR / Plastic Core / Aluminum Lock Ring

Weight : 168 g / pair

Color :



T-GP62C T-GP62G

GEO

Comfort Grip

T-GP26 / 27 / 28 / 29



T-GP26

Variant : Double Lock Ring Grip

Material : TPR / Plastic Core / Aluminum Lock Ring

Weight : 98 g / pair

Length : 130 mm

Color :



T-GP26G T-GP26B



T-GP27

Variant : Single Lock Ring Grip

Material : TPR / Plastic Core / Aluminum Lock Ring

Weight : 84 g / pair

Length : 130 mm

Color :



T-GP27G T-GP27B



T-GP28

Variant : One Piece Grip

Material : TPR

Weight : 100 g / pair

Length : 130 mm

Color :



T-GP28R T-GP28B



T-GP29

Variant : One Piece Grip

Material : TPR

Weight : 100 g / pair

Length : 130 mm

Color :



T-GP29G T-GP29B

GEO

Comfort Grip

T-GP27B

Color : Black

WAVE

Comfort Grip

T-GP11 / 12 / 13



T-GP11

Variant : Double Lock Ring Grip

Material : TPR / Plastic Core / Aluminum Lock Ring

Weight : 105 g / pair

Length : 130 mm

Color :



T-GP11B T-GP11G



T-GP12

Variant : One Piece Grip

Material : TPR

Weight : 110 g / pair

Length : 130 mm

Color :



T-GP12G T-GP12B



T-GP13

Variant : One Piece Grip

Material : TPR

Weight : 110 g / pair

Length : 130 mm

Color :



T-GP13B

BLADE

Stylish Grip

T-GP30 / 31 / 32



T-GP30

Variant : Double Lock Ring Grip

Material : TPR / Plastic Core / Aluminum Lock Ring

Weight : 101 g / pair

Length : 130 mm

Color :



T-GP30N T-GP30Y



T-GP31

Variant : Single Lock Ring Grip

Material : TPR / Plastic Core / Aluminum Lock Ring

Weight : 88 g / pair

Length : 130 mm

Color :



T-GP31W T-GP31R



T-GP32

Variant : One Piece Grip

Material : TPR

Weight : 107 g / pair

Length : 130 mm

Color :



T-GP31W T-GP31R

H2O

Stylish Grip

T-GP17 / 18 / 19



T-GP17

Variant : Double Lock Ring Grip

Material : TPR / Plastic Core / Aluminum Lock Ring

Weight : 98 g / pair

Length : 130 mm

Color :



T-GP17R T-GP17W



T-GP18

Variant : Single Lock Ring Grip

Material : TPR / Plastic Core / Aluminum Lock Ring

Weight : 94 g / pair

Length : 130 mm

Color :



T-GP18B T-GP18L



T-GP19

Variant : One Piece Grip

Material : TPR

Weight : 93 g / pair

Length : 130 mm

Color :



T-GP19G

TOWER II

Stylish Grip

T-GP03



T-GP03

Variant : One Piece Grip

Material : TPR

Weight : 102 g / pair

Length : 130 mm

EAGLE EYE

Bar end

T-BE01



T-BE01

Variant : Bar End

Material : Aluminum

Weight : 156 g / pair

Length : -





01



02



03



04



05

ROCK

Stylish Grip

T-GP33 / 34 / 35 / 36 / 37 / 38

01 x 2

T-GP33 (130mm x 2)

Variant : Double Lock Ring Grip
Material : TPR / Plastic Core / Aluminum Lock Ring

Weight : 97 g / pair

Color :



T-GP33B



T-GP33G

02 x 2

T-GP34 (130mm x 2)

Variant : Single Lock Ring Grip
Material : TPR / Plastic Core / Aluminum Lock Ring

Weight : 83 g / pair

Color :



T-GP34G

03 x 2

T-GP35 (130mm x 2)

Variant : One – piece grip

Material : TPR

Weight : 98 g / pair

Color :



T-GP35B

02 + 04

T-GP36 (130mm + 90mm)

Variant : Single Lock Ring Grip

Material : TPR / Plastic Core / Aluminum Lock Ring

Weight : 72 g / pair

Color :



T-GP36G

03 + 05

T-GP37 (130mm + 90mm)

Variant : One Piece Grip

Material : TPR

Weight : 83 g / pair

Color :



T-GP37B

04 x 2

T-GP38 (90mm x 2)

Variant : Single Lock Ring Grip

Material : TPR / Plastic Core / Aluminum Lock Ring

Weight : 62 g / pair

Color :



T-GP38G

DOT

Comfort Grip

T-GP39 / 40 / 41 / 42



T-GP39

Variant : Double Lock Ring Grip

Material : TPR / Plastic Core / Aluminum Lock Ring

Weight : 89 g / pair

Length : 130 mm

Color :



T-GP39B T-GP39G



T-GP40

Variant : Single Lock Ring Grip

Material : TPR / Plastic Core / Aluminum Lock Ring

Weight : 76 g / pair

Length : 130 mm

Color :



T-GP40B T-GP40G



T-GP41

Variant : One Piece Grip

Material : TPR

Weight : 91 g / pair

Length : 130 mm

Color :



T-GP41B T-GP41G



T-GP42

Variant : One Piece Grip

Material : TPR

Weight : 91 g / pair

Length : 130 mm

Color :



T-GP42G T-GP42B



LAYER

Comfort Grip

T-GP45 / 46 / 47 / 48



T-GP45

Variant : Double Lock Ring Grip

Material : TPR / Plastic Core / Aluminum Lock Ring

Weight : 111 g / pair

Length : 130 mm

Color :



T-GP45G T-GP45B



T-GP46

Variant : Single Lock Ring Grip

Material : TPR / Plastic Core / Aluminum Lock Ring

Weight : 104 g / pair

Length : 130 mm

Color :

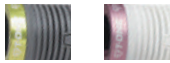

T-GP46G T-GP46W



T-GP47

Variant : One Piece Grip

Material : TPR

Weight : 116 g / pair

Length : 130 mm

Color :

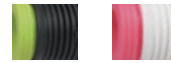

T-GP47B T-GP47W



T-GP48

Variant : One Piece Grip

Material : TPR

Weight : 116 g / pair

Length : 130 mm

Color :



T-GP48B T-GP48G

DNA

Stylish Grip

T-GP49 / 50 / 51 / 52



T-GP49

Variant : Double Lock Ring Grip

Material : TPR / Plastic Core / Aluminum Lock Ring

Weight : 85 g / pair

Length : 130 mm

Color :



T-GP49B T-GP49R



T-GP50

Variant : Single Lock Ring Grip

Material : TPR / Plastic Core / Aluminum Lock Ring

Weight : 76 g / pair

Length : 130 mm

Color :



T-GP50N T-GP50G



T-GP51

Variant : One Piece Grip

Material : TPR

Weight : 94 g / pair

Length : 130 mm

Color :

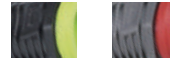

T-GP51B T-GP51G



T-GP52

Variant : One Piece Grip

Material : TPR

Weight : 94 g / pair

Length : 130 mm

Color :



T-GP52B T-GP52G



MR.FANTASTIC
Treat Pattern
T-TP05B
Color : Black

MR. FANTASTIC
Organic Pattern
T-TP04W
Color : White



Patented

DEAJ VU T-GP43

100% silicone grip

Weight : 70 g / pair

Length : 130 mm

Color :



Patented

DEAJ VUX T-GP43X

100% silicone grip

Weight : 70 g / pair

Length : 130 mm

Color :



MR.FANTASTIC T-TP01

100% silicone Bartape

Weight : 208 g / pair

Length : 2000 mm

Color :

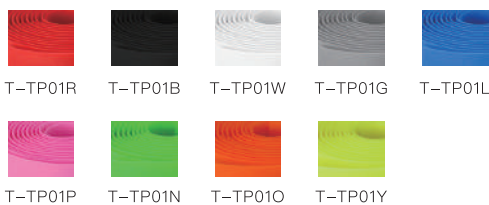



DNA

Stylish Grip

T-GP50T

Color : Transparent

DOT T-GP40**Comfort Grip**

- Variant :** Single Lock Ring Grip
Material : TPR / Plastic Core / Aluminum Lock Ring
Weight : 76 g / pair
Length : 130 mm
Color : T-GP40T

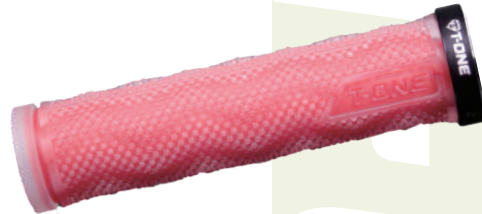
**DOT** T-GP41**Comfort Grip**

- Variant :** One Piece Grip
Material : TPR
Weight : 91 g / pair
Length : 130 mm
Color : T-GP41T

**DNA** T-GP50**Stylish Grip**

- Variant :** Single Lock Ring Grip
Material : TPR / Plastic Core / Aluminum Lock Ring
Weight : 76 g / pair
Length : 130 mm
Color : T-GP50T



MIRRORS

WATCHOUT II ▶

T-MR05





◀ VISION II
T-MR02



VISION

T-MR01

Material :

Stainless steel lens
 reinforced plastic housing
 Aluminum stem

Weight : 129 g / pair

Length : 83 mm x 64 mm

Handlebar Diameter :
 22.2 mm

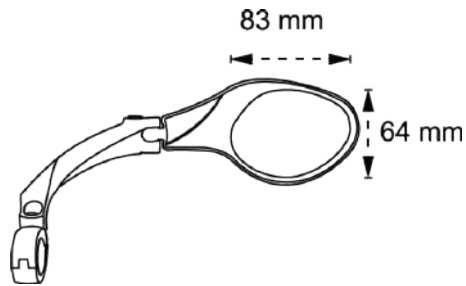

▲ FRONT



▲ BACK



SPIEGEL

T-MR08

Material :

Stainless steel lens
 reinforced plastic housing
 Aluminum stem

Weight : 130 g / pair

Length : 120 mm x 60 mm

Handlebar Diameter:
 21 – 26 mm

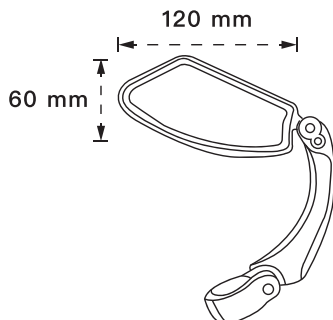

▲ FRONT



▲ BACK

VISION II

T-MR02

VISION II

T-MR02

Material :

Stainless steel lens
reinforced plastic housing
Aluminum stem

Weight : 73 g / pair

Length : 62 mm

Handlebar Diameter: :

16 ~ 21 mm

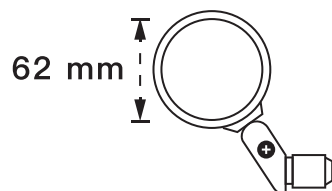



WATCHOUT
T-MR04

WATCHOUT

T-MR04

Material :

- Convex lens
- ABS housing
- Aluminium stem

Weight : 179 g / pair

Length : 95 mm

Handlebar Diameter : 22.2 mm

E-Mark: L E4 000513

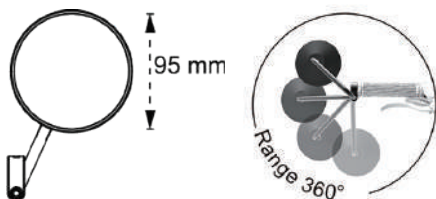

WATCHOUT II

T-MR05

Material :

Convex lens
ABS housing
Alumium stem

Weight : 184 g / pair

Length : 105 mm x 80 mm

Handlebar Diameter : 22.2 mm

E-Mark: L E4 000514

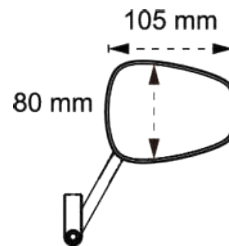

WATCHOUT II

T-MR05





BAGS

Saddle Bags

Top Tube Bags

Pannier Bag

PELICAN M/S T-BG28M/S

Expantable Saddle Bag

- Water Resistant
- Reflective

Material : TPU / 600 Denier Nylon

Weight : M 110 g / S 83 g

Size : M 170 x 95 x 110 mm

S 155 x 75 x 80 mm

Color :



T-BG28MN T-BG28MG



▲ Expandable Capacity



Aillight Hanger

Niversal Velcro Strap



Reflective Stripe



Large Opening



PAC T-BG30

Saddle Bag

- Water Resistant
- Reflective

Material : TPU / 600 Denier Nylon

Weight : 83 g

Size : 130 x 70 x 140 mm



Aillight Hanger

Niversal Velcro Strap



Reflective Stripe



Large Opening



SLIT T-BG31

Top Tube Bag

- Water Resistant
- Reflective

Material : TPU / 600 Denier Nylon

Weight : 150 g

Size : 210 x 95 x 50 mm

Inside elastic band for
Fixing riding gears stably.



Easy access for reaching
Stuffs within a second.



Nonslip fabric on
the bottom.

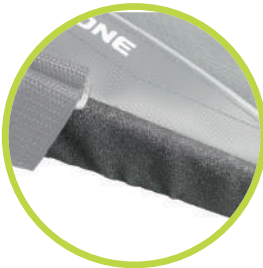

SINGLE T-BG32

Smart Phone Top Tube Bag

- Water Resistant
- Reflective

Material : TPU / 600 Denier Nylon

Weight : 130 g

Size : 175 x 90 x 80 mm

1. Sensitive touching screen.
2. Screen size up to 5 inches.



Nonslip fabric on the bottom.

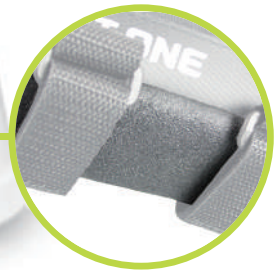

Rubber cable exit grommet facing rider.



VOYAGE T-BG10

Pannier Bag

- Water Resistant
- Reflective

Material : TPU / 600 Denier Nylon

Weight : 1000 g

Size : 275 x 400 x 110 mm



SINGLE 6 T-BG33

Smart Phone Top Tube Bag

- Water Resistant

Material : 600 Denier Nylon

Weight : 107 g

Size : 180 x 100 x 90 mm



VOYAGE

Pannier Bag
T-BG10





TOOLS



SINGLE SPORT

T-FT03

Weight : 100 g

Allen Key : 3 / 4 / 5 / 6 / 8 mm



N-Tool+

T-ST02

Material :

Aluminum Handle / Steel Tools

Weight : 53 g

Size : 110 x 90 x 12 mm

HEX : 4 / 5 / 6 mm

Star Shaped : T25



CUBIC 8

T-FT04

Material :

Aluminum Handle / Steel Tools

Weight : 62 g

Size : 73 x 29 x 7 mm

HEX :

2 / 2.5 / 3 / 4 / 5 / 6 mm

Star Shaped : T25 / T15 - SL5

SINGLE SPORT

T-FT03

Weight : 100 g

Allen Key : 3 / 4 / 5 / 6 / 8 mm



CUBIC 6

T-FT05

Material :

Aluminum Handle / Steel Tools

Weight : 54 g

Size : 79 x 28 x 7 mm

HEX : 3 / 4 / 5 / 6 mm

Star Shaped : T25 - SL5

TRI 11

T-FT07

Material :

Aluminum Handle / Steel Tools

Weight : 93 g

Size : 73 x 35 x 15 mm

HEX : 2 / 2.5 / 3 / 4 / 5 / 6 / 8 mm

Star Shaped : T25 / T15 – SL5 – PH2



Patented

TRI 13



T-FT06

Material :

Aluminum Handle / Steel Tools

Weight : 122 g

Size : 73 x 35.5 x 15 mm

HEX :

2 / 2.5 / 3 / 4 / 5 / 6 / 8 mm

Star Shaped :

T25 / T15 – SL5 – PH1 / PH2

Chain Breaker :

9 / 10 / 11 speed

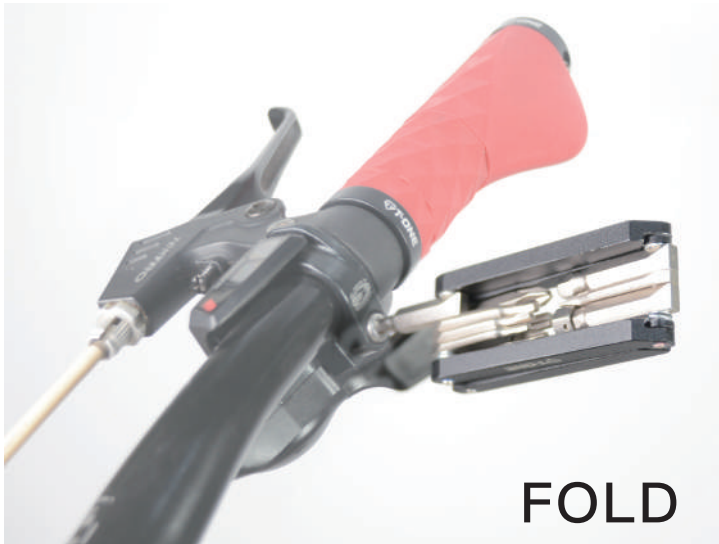

FOLD



UNFOLD

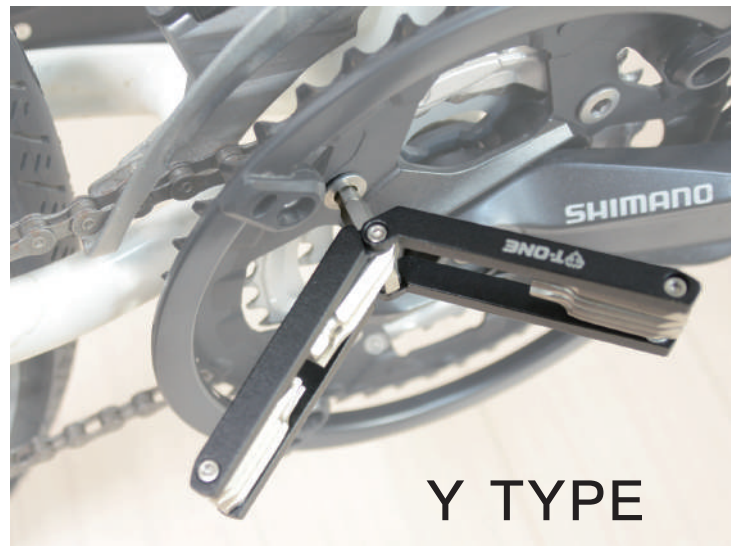

Y TYPE



T TYPE



A person is riding a bicycle on a blue, textured path that curves through a park. The path is bordered by a grassy embankment on the left and a dirt path on the right. In the background, there are several trees and white utility poles with blue accents. The sky is clear and blue. The person's hand is visible on the handlebar, which has a brown grip.

MOUNTING SYSTEM

Front / Stem

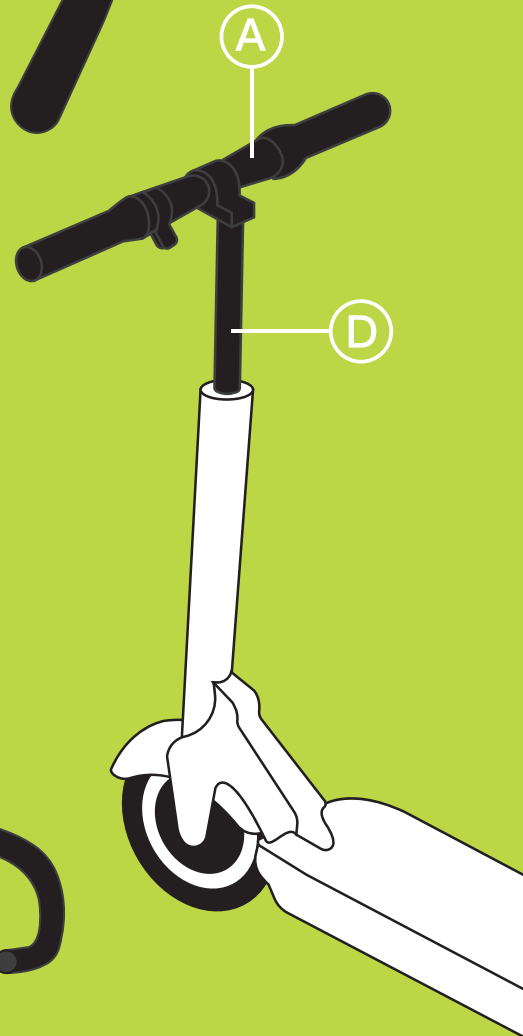
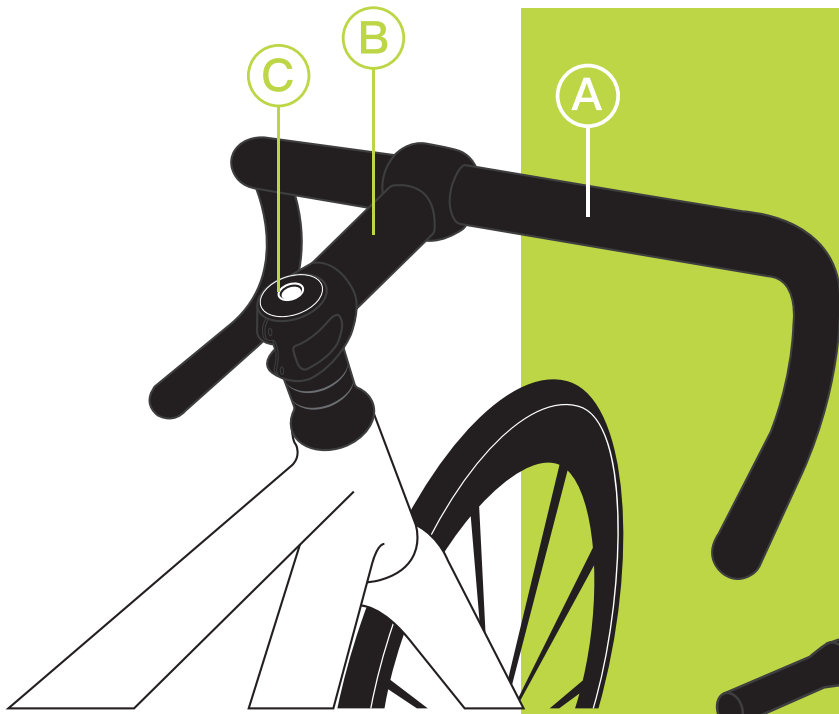

A B
D E**SHIFT**

(T-HW07)

Bar bore size:

35 / 31.8 / 25.4 / 22.2 mm



A

**PYLON**

(T-HW01)

Handlebar Diameter:

22.2 mm

**TALONG II**

(T-HW05X)

Handlebar Diameter:

31.8 mm / 25.4 mm



C

**PACKMAN PLUS**

(T-HW04)

Suitable for threadless stem :

11/8" threadless headset

**UNO**

(T-HW06)

Suitable for threadless stem :

11/8" threadless headset

**PACKMAN**

(T-HW02)

Suitable for threadless stem :

11/8" threadless headset



D E

**QUI-CK**

(T-HW03)

Suitable for threadless stem :

11/8" threadless headset



TALONG II T-HW05X

Handlebar cleat

- Switchable for 2 different sizes
- Compatible with e-bike displays, e.g. Bosch

Material : Aluminum Clamp / Nylon + Fiber

Weight : 138 g

Handlebar Diameter: 31.8 mm / 25.4 mm

Max. : 5 kg



Handlebar Diameter : 31.8 mm / 25.4 mm

T-HW05X + T-BG27

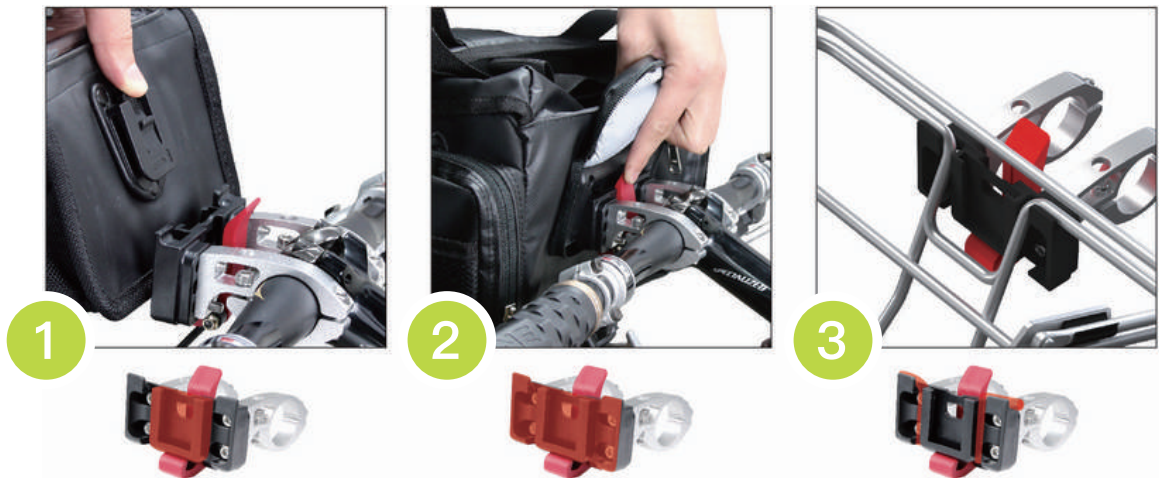

QUAN T-BK02

Front cleat bag

Material : Aluminum Frame / PP Mount

Weight : 800 g

Size: 250 x 330 x 250 mm

Max. : 5 kg



T-HW05X (TALONG II)



1



2



3

T-HW05 + T-BK02 (QUAN)

1



2



3



T-HW05 + T-BG22 (TROOPER)

1



2



3





TROOPER T-BG22

Front cleat bag

- Water Resistant
- Reflective

Material : TPU / Nylon

Weight : 500 g

Size: 270 x 150 x 190 mm



T-HW05X (TALONG II)



PYLON T-HW01

Handlebar cleat

- Handlebar Diameter: 22.2 mm

Material : Aluminum Clamp / Nylon + Fiber

Weight : 50 g

Bar bore size: 22.2 mm

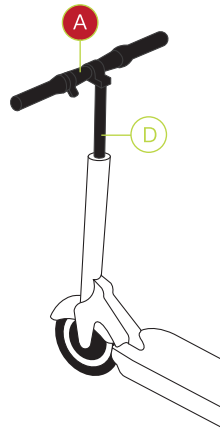
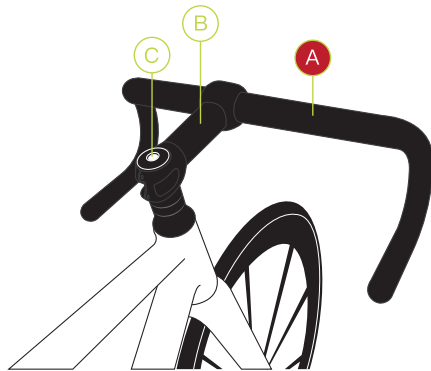

Handlebar Diameter: 22.2 mm

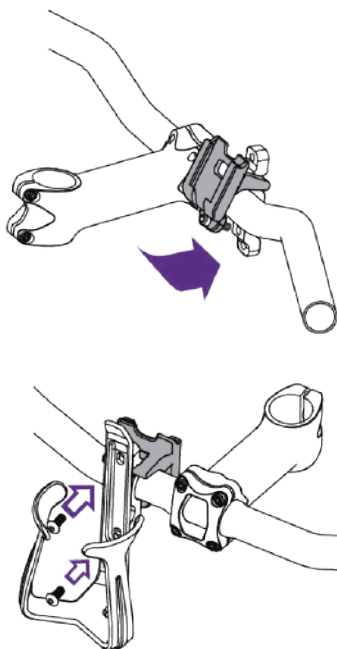

PACKMAN T-HW02

Stem cleat

Material : Nylon+Fiber

Weight : 28 g

Suitable for threadless stem : 11/8" threadless headset

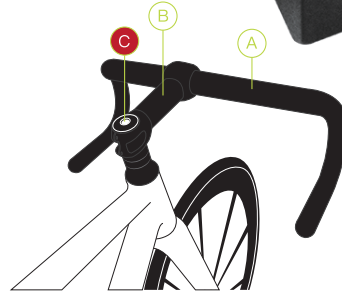
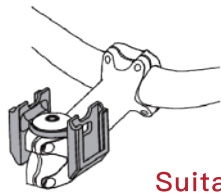
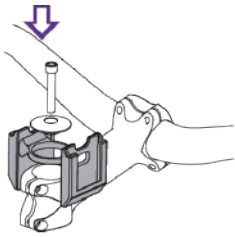

Suitable for threadless stem : 11/8"



PACKMAN PLUS T-HW04

Stem cleat

- Angle Adjustable

Material : Nylon+Fiber / Stainless Steel

Weight : 24 g

Suitable for threadless stem : 11/8" threadless headset

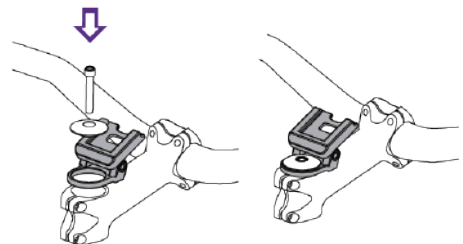
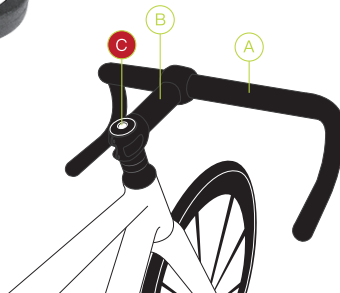

Suitable for threadless stem : 11/8"



QUI-CK T-HW03

Stem cleat

- The two-sided mount places two different bags.

Material : Nylon+Fiber

Weight : 43 g

Suitable for threadless stem :

11/8" threadless headset

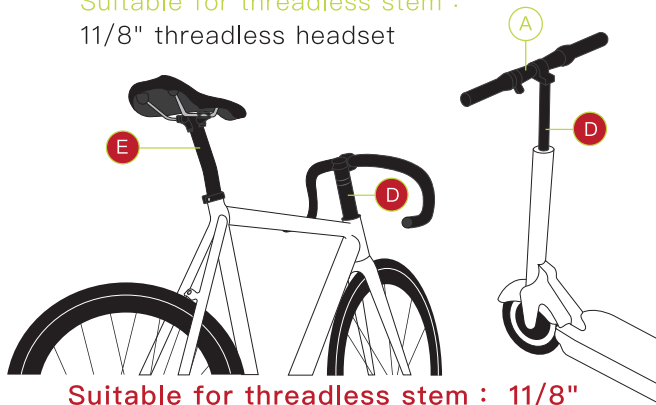

Suitable for threadless stem : 11/8"

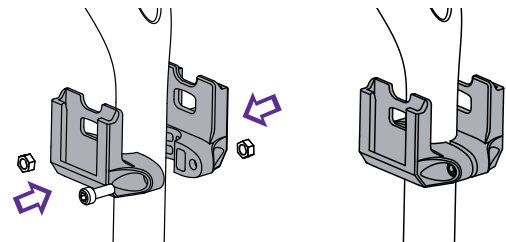

QUI-CK

T-HW03

Stem cleat

T-ONE 65

MOUNTING SYSTEM

UNO

T-HW06

Handlebar cleat



UNO T-HW06

Handlebar cleat

Material : Nylon+Fiber

Weight : 15 g

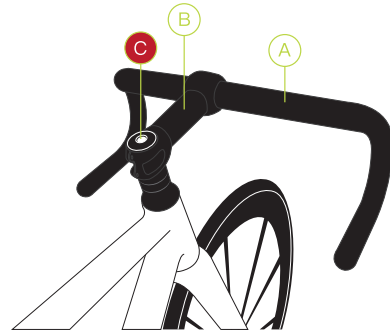
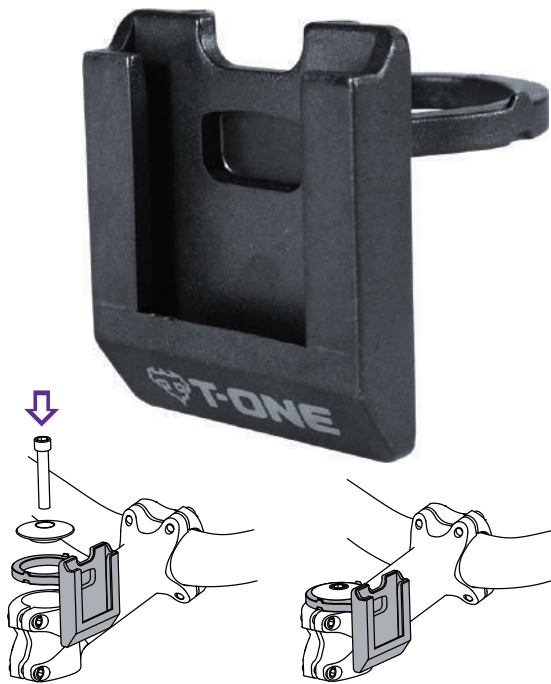
Suitable for threadless stem :
1 1/8" threadless headset

Suitable for threadless stem : 1 1/8"

**NARO** T-BG16

Stem cleat bag

- Water Resistant

Material : TPU

Weight : 76 g

Size: 90 x 140 x 40 mm



T-HW02 (PACKMAN) T-HW03 (QUI-CK) T-HW06 (UNO)

Patented

SHIFT T-HW07

Adjustable cleat

Turn freely to desired position, 8 positions allowed. (stops every 45°)

- Angle Adjustable

Material : Nylon+Fiber / Stainless Steel

Weight : 55 g

Bar bore size:

35 / 31.8 / 25.4 / 22.2 mm

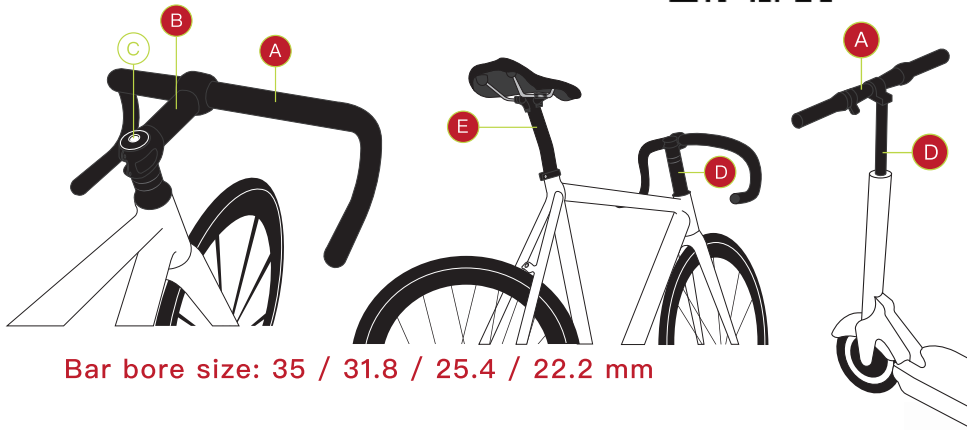

Bar bore size: 35 / 31.8 / 25.4 / 22.2 mm

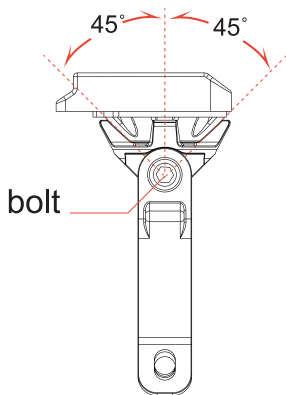

Turn freely to desired position, 8 positions allowed. (stops every 45°)

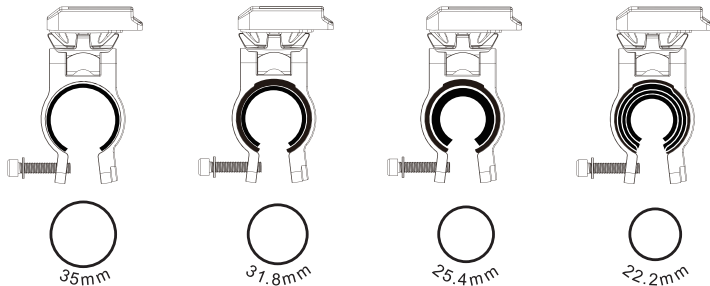
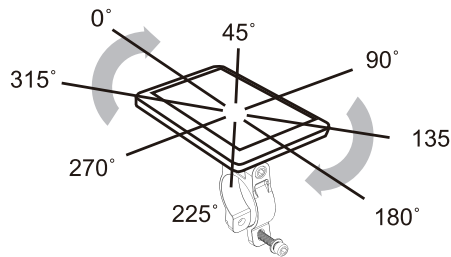

1mm rubber.

One plastic shim + 1mm rubber.

One plastic shim + 2mm rubber.

Two plastic shim + 1mm rubber.



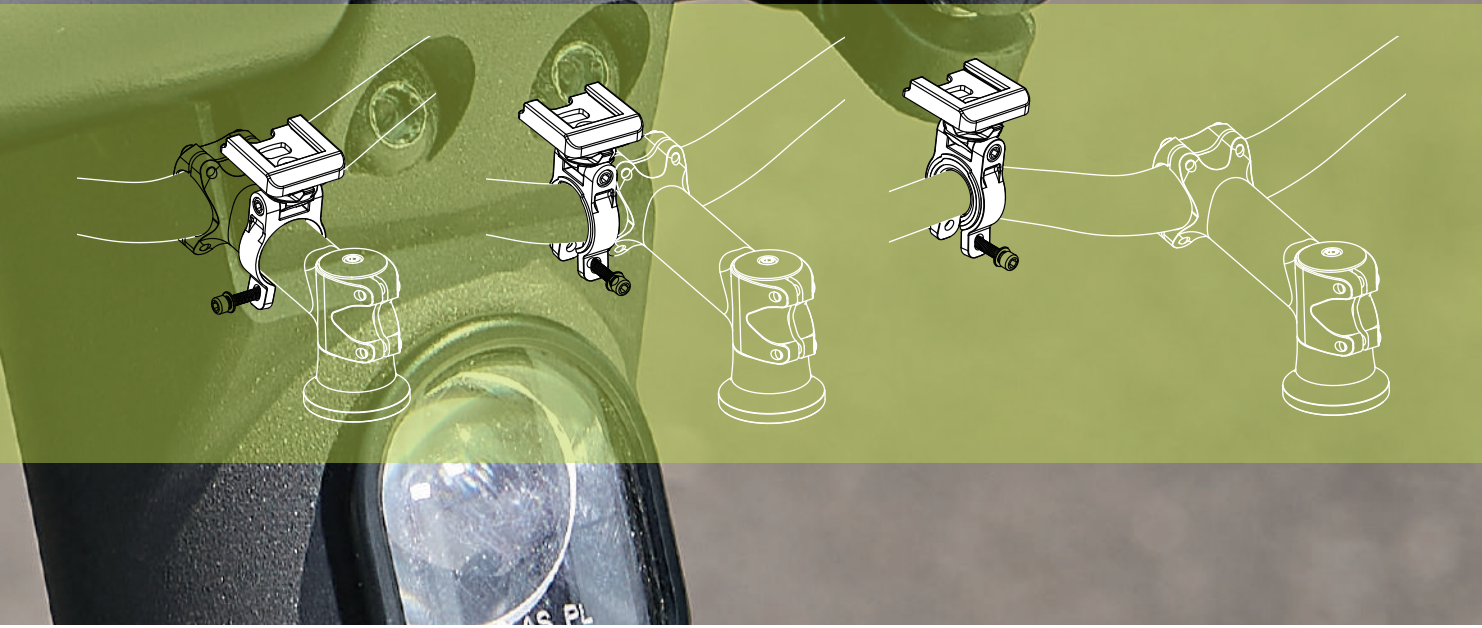



POKEMON + T-BG25

Smart phone cleat bag

- Water Resistant

Material : TPU / Nylon

Weight : 59 g

Size: 176 x 109 x 12 mm

Applicable mobile phone size : 5.5" ~ 6"



T-HW01 (PYLON)



T-HW07 (SHIFT)



T-HW04 (PACKMAN PLUS)

AKULA + T-BG26

Waterproof Smart phone cleat bag

- Waterproof

Material : PU / TPU

Weight : 61 g

Size: 170 x 112 x 12 mm

Applicable mobile phone size : iphone6 plus or 5.5"



T-HW01 (PYLON)



T-HW07 (SHIFT)



T-HW04 (PACKMAN PLUS)





T-ONE

POKEMON +

T-BG25

Smart phone cleat bag



E. Wiener Bike Parts GmbH

📍 Max-Planck-Strasse 8, 97526 Sennfeld, Germany

✉ E-mail : info@bike-parts.de

☎ Tel : +49 (0)9721 65018762

📠 Fax : +49 (0)9721 650197

🌐 Web : www.bike-parts.de

- Germany
- Netherlands
- Belgium
- Luxembourg
- Italy
- Czech Republic
- Poland
- Denmark
- Cyprus
- Sweden
- Portugal
- Croatia
- Slovakia
- Romania
- Greece

Zweirad Einkaufs-Genossenschaft eG(ZEG)

📍 Longericher Str. 2, 50739 Koln

☎ Tel : +49 (0)221 17959-0

📠 Fax : +49 (0)221 17959-31

🌐 Web : www.zeg.com

- Germany

PROFIL BICYCLES CZ

📍 Hněvotín 31, 783 47 Hněvotín

✉ objednavky@profil-bicycles.cz

☎ Tel : +420 585 754 440

🌐 Web : www.profilshop.cz

- Czech Republic

BLUE LEPORTS CO., LTD. (주)블루레포트츠

📍 #712-9 JIWOL, CHOWOL, GWANGJU, KYOUNGKI, KOREA 12728

경기도 광주시 초월읍 지월리 712-9

☎ Tel : 82-31-793-4037/4038

📠 Fax : 82-31-793-4039

🌐 Web : www.blueleports.com

- Korea

CYCLE SPORT CO., LTD.

📍 167Luang Road,Pomprab,Bangkok 10100, Thailand

✉ E-mail : info@cyclesport-th.com

☎ Tel : +66(0)26217224

🌐 Web : www.cyclesport-th.com

- Thailand

T-ONE



T-ONE R & D CORP.
www.T-oneDesign.com

T-ONE
TRI
Multi-functional Folding Tool

DESIGN
T-ONE R&D Corp.
Eric Wang

MANUFACTURER
T-ONE R&D Corp.

Organizers
TATRA

Sponsor
T-ONE

322-21948



if

product design award

2010

Anyway
Trinkflaschen-Halter
Bottle cage

Design
T-ONE R&D Corp.
Jeremy Hsu
Taiwan

Manufacturer
T-ONE R&D Corp.
Taiwan



To Be Continued.

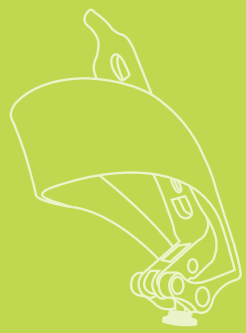



www.T-one Design.com



味年國際股份有限公司

T-ONE R&D CORP.

TEL :+886-4-23592618

FAX :+886-4-23592616

E-mail :T-one@T-oneDesign.com