



# T-ONE



Creation  
For  
Solution

2023 ▶ 2024

CATALOG

# ABOUT

Founded in 2007, T-ONE is soon welcoming our 17th anniversary. Witnessing how bicycles changing the world, the cities and people, and noticing how everyday riders are missing from the industry, we redirect our mission.

Cycling is just like human life, it comes with various purposes, leads to different destinations, and should have changeful looks. Hence, T-ONE is now designing bike accessories that not only light up your cycling experience, but also suit to your multi-riding styles. As a bike modern minimalism, we create accessories that are safe, simple and easy-to-use, and speak up your own style.

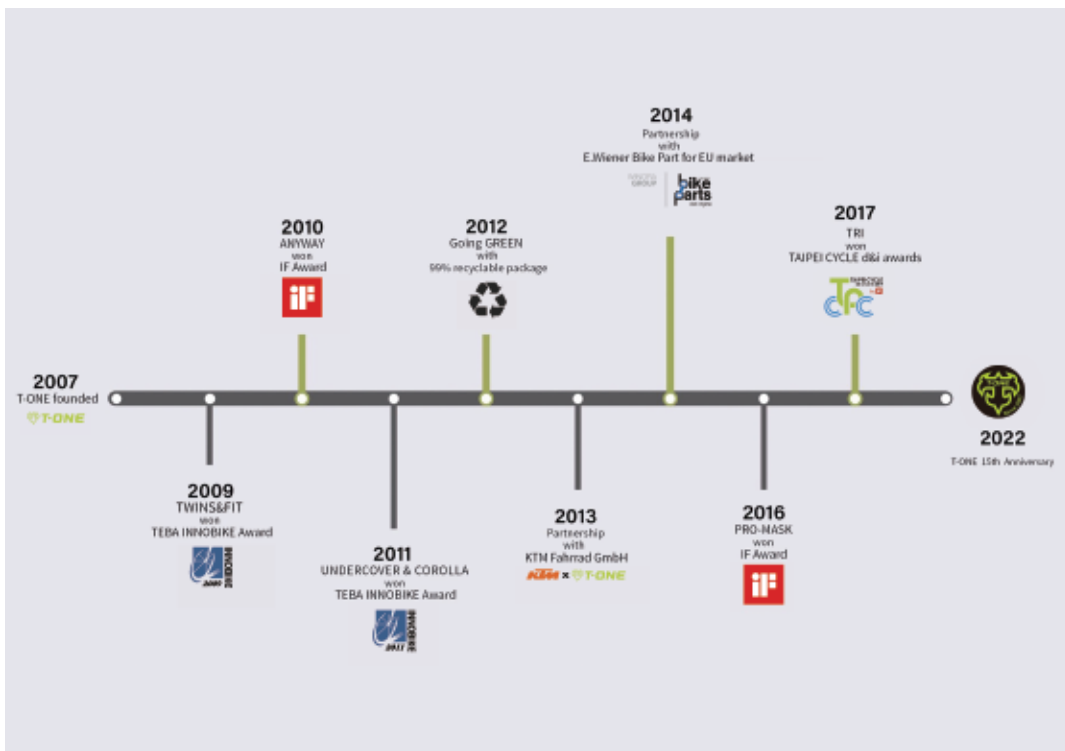



# CONTENTS

**01** BOTTLE CAGES

**15** GRIPS & TAPES

**35** MIRRORS

**41** BAGS

Saddle Bags/Top Tube Bags/Pannier Bag

**49** TOOLS

**55** MOUNTING SYSTEM

Front/Stem





## SPLASH

BPA-Free Bottle  
T-BT01W  
Color : White

## FIT WELL Patented

Adjustable Bottle Cage  
T-BC14G  
Color : Grey

# BOTTLE CAGES







**NEW** Patented

# FIT WELL

T-BC14



T-BC14L



T-BC14G



T-BC14P

**NEW**

## FIT WELL Patented

Adjustable Bottle Cage

T-BC14

Material : Reinforced plastic

Weight : 95 g

Size Adjustment : 60 to 85mm

Color :



T-BC14P T-BC14G T-BC14L

### PRACTICABILITY

All common bottles on the market can be fitted.





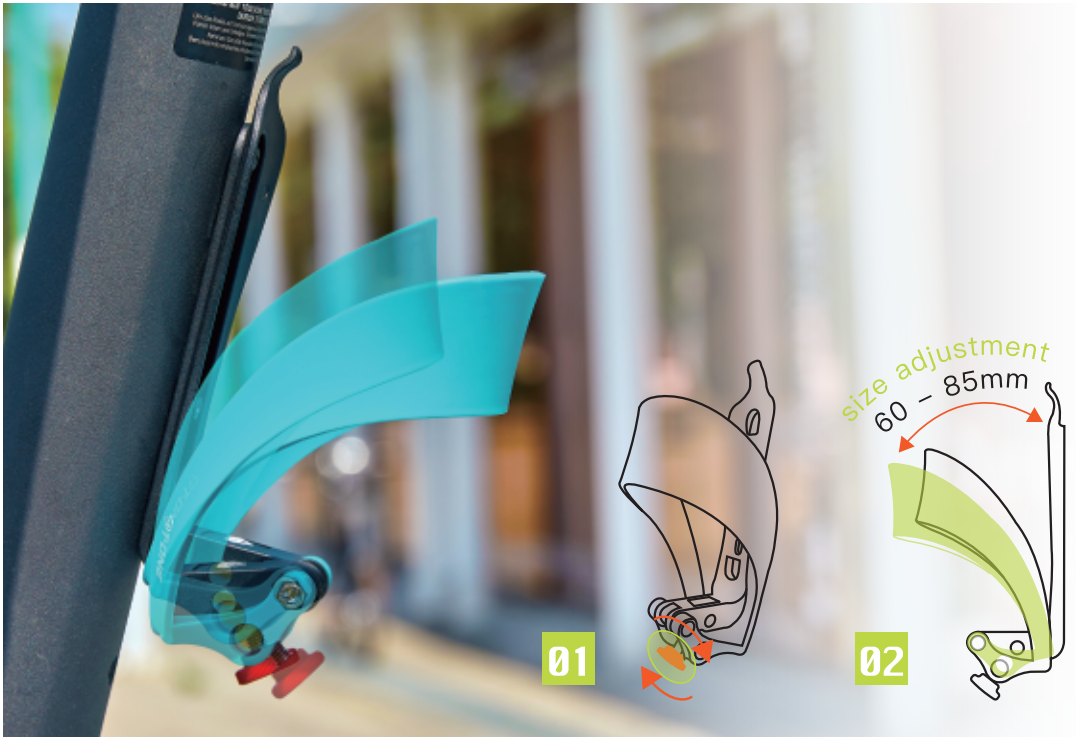





Patented



**ANYWAY** T-BC03

Adjustable Bottle Cage



This cage is shaped by lightweight pressed aluminum and weighs only 24g. Cyclists, both right-handed and left-handed, can easily adjust the angle by moving the bolt position.



Material : Aluminium

Weight : 24 g

Color :



T-BC03S T-BC03R T-BC03B T-BC03W

Patented

**ANYWAY R** T-BCN3

Adjustable Bottle Cage

ANYWAY R , the advanced version ANYWAY that comes with the reflective decal to increase the safety of cycling.



Material : Aluminium

Weight : 24 g

Color :



T-BCN3S T-BCN3R T-BCN3B T-BCN3W



■ ■ Reflective Colors

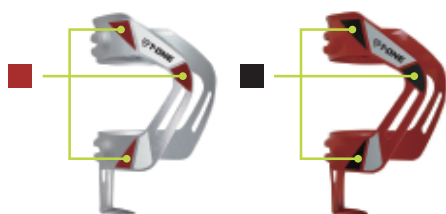

Reflective



Patented

**ORBIT** T-BC12

Adjustable Bottle Cage

ORBIT, the plastic version ANYWAY, which not only retains the angle adjustable feature but also provides more flexibility to cage itself due to the material.

Material : Reinforced plastic

Weight : 42 g

Color :



T-BC12R T-BC12B T-BC12W



### Instructions For Use

105°

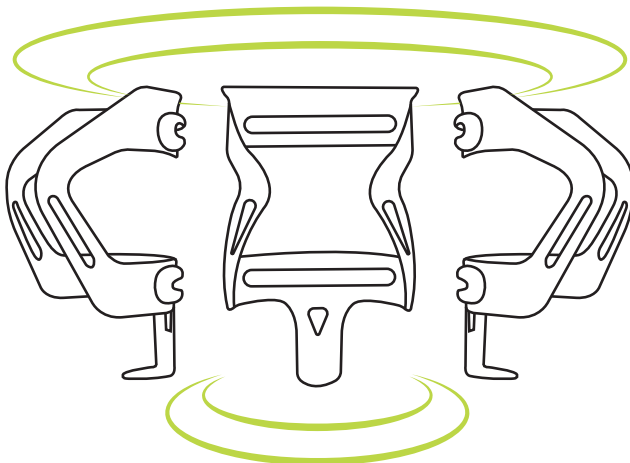



Pull-up 

**UP2U** Patented

Adjustable Bottle Cage

T-BC10W

Color : White



Patented

**UP2U** T-BC10

Adjustable Bottle Cage

UP2U provides 2 different cage structures in ONE cage, easily adjust by flipping over the cage upside down.

Material : Reinforced plastic

Weight : 40 g

Color :



T-BC10Y T-BC10O T-BC10W T-BC10T

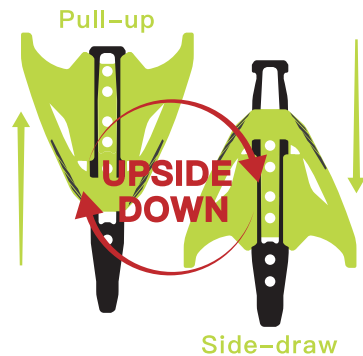





Pull-up



Side-draw



UP2U Patented  
Adjustable Bottle Cage  
T-BC10Y  
Color : Yellow

◀ Side-draw

## X-WING

Plastic Bottle Cage

T-BC07B

Color : Black



## X-WING T-BC07

Plastic Bottle Cage

Material : Reinforced plastic

Weight : 47 g

Color :



T-BC07N T-BC07R T-BC07B T-BC07W



T-BC07Y T-BC07O T-BC07B T-BC07T





**X-WING D** T-BCD7

Plastic Bottle Cage

Material : Reinforced plastic

Weight : 50 g

Color :



T-BCD7R T-BCD7B T-BCD7W



**RAY** T-BC13

Plastic Bottle Cage

Material : Reinforced plastic

Weight : 35 g

Color :



T-BC13N T-BC13R T-BC13B



T-BC13T T-BC13W



Matt Surface

Shiny Surface



**COROLLA** T-BC06

Plastic Bottle Cage

COROLLA adapts the water bottle from 64mm to 74mm in diameter.

Material : Reinforced plastic

Weight : 45 g

Color :



T-BC06B T-BC06W

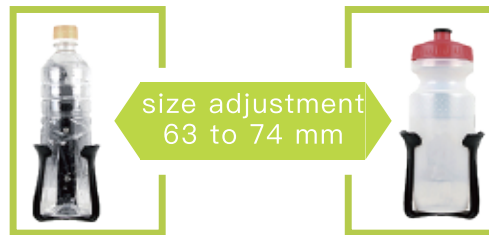

Patented

**UPNDOWN** T-BC09

Adjustable Bottle Cage

5 different combinations in height position, ranging up to 30mm.

Material : Reinforced plastic

Weight : 44 g

Color :



T-BC09N T-BC09R T-BC09B T-BC09W



▲ Adjusting Range up to 30mm

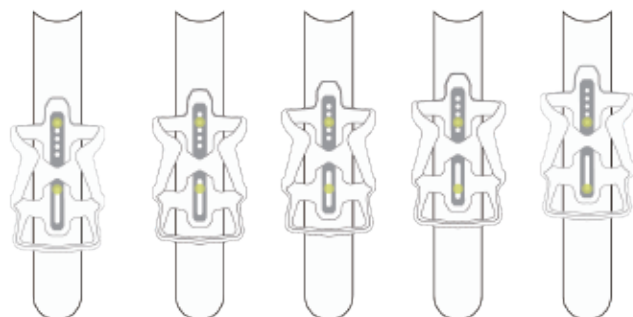



**FIX** T-BC08

Plastic Bottle Cage

Material : Reinforced plastic

Weight : 38 g

Color :



T-BC08P T-BC08R T-BC08B T-BC08W



T-BC08T



Patented

**COBRA** T-BC11

Carbon Bottle Cage

Material : Carbon fiber

Weight : 20 g

Color :



T-BC11Y T-BC11R T-BC11M





**UP2U** Patented

Adjustable Bottle Cage

T-BC10T

Color : Transparent



**X-WING** T-BC07

Plastic Bottle Cage

Material : Reinforced plastic

Weight : 47 g

Color : Transparent



Patented

**UP2U** T-BC10

Adjustable Bottle Cage

Material : Reinforced plastic

Weight : 40 g

Color : Transparent

**RAY** T-BC13

Plastic Bottle Cage

Material : Reinforced plastic

Weight : 35 g

Color : Transparent



Patented

## DIAMOND PLUS

Adjustable Grip

T-GP61L

Color : Blue



GRIPS  
&  
TAPES



**AERO**

Comfort Grip

T-GP53B

Color : Black

**SPLASH**

BPA-Free Bottle

T-BT01W

Color : White

**FIT WELL** Patented

Adjustable Bottle Cage

T-BC14L

Color : Blue





Patented

## DIAMOND T-GP60

Adjustable Grip

Variant : Double Lock Ring Grip

Material : TPR / Plastic Core / Aluminum Clamp

Weight : 148 g / pair

Length : 94 \ 104 \ 114 mm....

Color :



T-GP60B T-GP60R T-GP60L

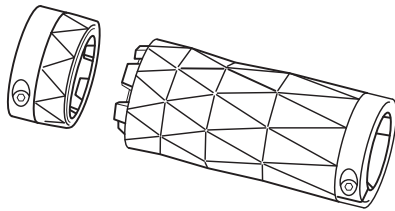

▲ basic length 94 mm

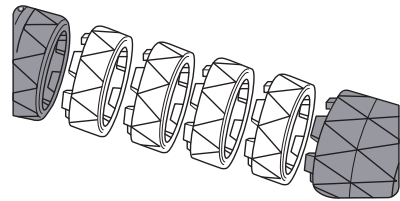

▲ 10 mm spacers x4

Patented

## DIAMOND PLUS T-GP61

Adjustable Grip

Variant : Double Lock Ring Grip

Material : TPR / Plastic Core / Aluminum Clamp

Weight : 182 g / pair

Length : 94 \ 104 \ 114 mm....

Color :



T-GP61L T-GP61R T-GP61B







## AERO

Comfort Grip

T-GP53B

Color : Black



## AERO

Comfort Grip

T-GP53 / 54 / 55 / 56 / 57 / 58 / 59



01



04



02



05



03





**01 x 2**T-GP53 (130mm x 2)

Variant : Double Lock Ring Grip

Material : TPR / Plastic Core /  
Aluminum Lock Ring

Weight : 140 g / pair

Color :

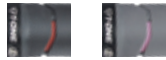

T-GP53B T-GP53G

**02 x 2**T-GP54 (130mm x 2)

Variant : Single Lock Ring Grip

Material : TPR / Plastic Core /  
Aluminum Lock Ring

Weight : 146 g / pair

Color :

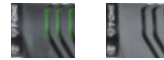

T-GP54B T-GP54G

**03 x 2**T-GP55 (90mm x 2)

Variant : Single Lock Ring Grip

Material : TPR / Plastic Core /  
Aluminum Lock Ring

Weight : 102 g / pair

Color :



T-GP55B T-GP55G

**02 + 03**T-GP56 (130mm + 90mm)

Variant : Single Lock Ring Grip

Material : TPR / Plastic Core /  
Aluminum Lock Ring

Weight : 115 g / pair

Color :

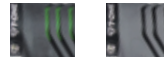

T-GP56B T-GP56G

**05 x 2**T-GP58 (90mm x 2)

Variant : One Piece Grip

Material : TPR

Weight : 78 g / pair

Color :



T-GP58B

**04 + 05**T-GP59 (130mm + 90mm)

Variant : One Piece Grip

Material : TPR

Weight : 111 g / pair

Color :



T-GP59B

**04 x 2**T-GP57 (130mm x 2)

Variant : One Piece Grip

Material : TPR

Weight : 144 g / pair

Color :



T-GP57B



**EZ**

Comfort Grip  
T-GP16  
Color : Black

**EZ**

Comfort Grip  
T-GP14 / 15 / 16



**T-GP14**

**Variant :** Double Lock Ring Grip  
**Material :** TPR / Plastic Core / Aluminum Lock Ring  
**Weight :** 155 g / pair  
**Length :** 130 mm  
**Color :**



T-GP14B T-GP14G

**T-GP15 / T-GP15A**

**Variant :** Double Lock Ring Grip / Single Lock Ring Grip  
**Material :** TPR / Plastic Core / Aluminum Lock Ring  
**Weight :** 155 / 146 g / pair  
**Length :** 130 mm  
**Color :**



T-GP15B T-GP15A

**T-GP16**

**Variant :** One Piece Grip  
**Material :** TPR  
**Weight :** 146 g / pair  
**Length :** 130 mm  
**Color :**



T-GP16



01



02



03



04



05

## MOVE

Comfort Grip

T-GP20 / 21 / 22 / 23 / 24 / 25

### 01 x 2

T-GP20 (130mm x 2)

**Variant :** Double Lock Ring Grip

**Material :** TPR / Plastic Core / Aluminum Lock Ring

**Weight :** 98 g / pair

**Color :**



T-GP20W

### 02 x 2

T-GP21 (130mm x 2)

**Variant :** Single Lock Ring Grip

**Material :** TPR / Plastic Core / Aluminum Lock Ring

**Weight :** 94 g / pair

**Color :**



T-GP21G

### 03 x 2

T-GP22 (130mm x 2)

**Variant :** One Piece Grip

**Material :** TPR

**Weight :** 80 g / pair

**Color :**



T-GP22B

### 02 + 04

T-GP23 (130mm + 90mm)

**Variant :** Single Lock Ring Grip

**Material :** TPR / Plastic Core / Aluminum Lock Ring

**Weight :** 98 g / pair

**Color :**



T-GP23G

### 03 + 05

T-GP24 (130mm + 90mm)

**Variant :** One Piece Grip

**Material :** TPR

**Weight :** 94 g / pair

**Color :**



T-GP24B

### 04 x 2

T-GP25 (90mm x 2)

**Variant :** Single Lock Ring Grip

**Material :** TPR / Plastic Core / Aluminum Lock Ring

**Weight :** 80 g / pair

**Color :**



T-GP25G



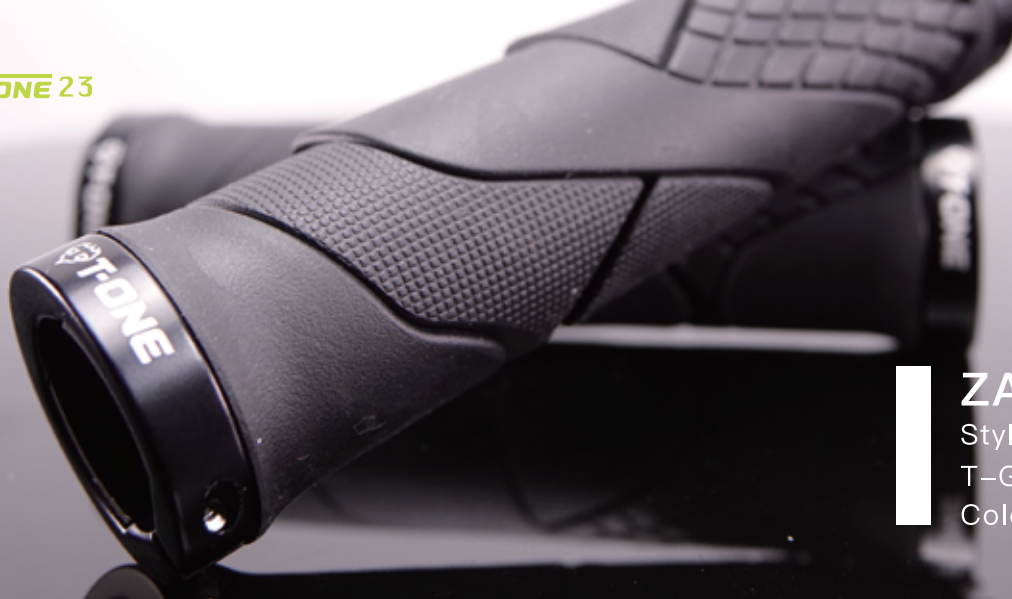

## ZAHA

Stylish Grip

T-GP69

Color : Black

## ZAHA

Stylish Grip

T-GP69 / 70 / 71



T-GP69

Variant : Double Lock Ring Grip

Material : TPR / Plastic Core / Aluminum Lock Ring

Weight : 120.3 g / pair

Length : 130 mm



T-GP70

Variant : Single Lock Ring Grip

Material : TPR / Plastic Core / Aluminum Lock Ring

Weight : 109.7 g / pair

Length : 130 mm



T-GP71

Variant : One Piece Grip

Material : TPR

Weight : 123 g / pair

Length : 130 mm

## ZAHA PLUS

Comfort Grip

T-GP72 / 73 / 74



T-GP72

Variant : Double Lock Ring Grip

Material : TPR / Plastic Core / Aluminum Lock Ring

Weight : 153.3 g / pair

Length : 130 mm



T-GP73

Variant : Single Lock Ring Grip

Material : TPR / Plastic Core / Aluminum Lock Ring

Weight : 141.7 g / pair

Length : 130 mm



T-GP74

Variant : One Piece Grip

Material : TPR

Weight : 154.5 g / pair

Length : 130 mm



01



02



03



04



05



## RIPPLE

Comfort Grip

T-GP62 / 63 / 64 / 65 / 66 / 67 / 68

### 01 x 2

T-GP62 (130mm x 2)

Variant : Double Lock Ring Grip

Material : TPR / Plastic Core / Aluminum Lock Ring

Weight : 168 g / pair

Color :



T-GP62C T-GP62G

### 02 x 2

T-GP63 (130mm x 2)

Variant : Single Lock Ring Grip

Material : TPR / Plastic Core / Aluminum Lock Ring

Weight : 166 g / pair

Color :



T-GP63G T-GP63N

### 03 x 2

T-GP64 (90mm x 2)

Variant : Single Lock Ring Grip

Material : TPR / Plastic Core / Aluminum Lock Ring

Weight : 132 g / pair

Color :



T-GP64G T-GP64N

### 02 + 03

T-GP65 (130 mm + 90 mm)

Variant : Single Lock Ring Grip

Material : TPR / Plastic Core / Aluminum Lock Ring

Weight : 149 g / pair

Color :



T-GP65G T-GP65N

### 04 x 2

T-GP66 (130mm x 2)

Variant : One Piece Grip

Material : TPR

Weight : 176 g / pair

Color :



T-GP66L T-GP66G

### 05 x 2

T-GP67 (90mm x 2)

Variant : One Piece Grip

Material : TPR

Weight : 136 g / pair

Color :



T-GP67L T-GP67G

### 04 + 05

T-GP68 (130mm + 90 mm)

Variant : One Piece Grip

Material : TPR

Weight : 156 g / pair

Color :



T-GP68L T-GP68G

# GEO

Comfort Grip

T-GP26 / 27 / 28 / 29



## T-GP26

**Variant :** Double Lock Ring Grip

**Material :** TPR / Plastic Core / Aluminum Lock Ring

**Weight :** 98 g / pair

**Length :** 130 mm

**Color :**



T-GP26G T-GP26B



## T-GP27

**Variant :** Single Lock Ring Grip

**Material :** TPR / Plastic Core / Aluminum Lock Ring

**Weight :** 84 g / pair

**Length :** 130 mm

**Color :**



T-GP27G T-GP27B



## T-GP28

**Variant :** One Piece Grip

**Material :** TPR

**Weight :** 100 g / pair

**Length :** 130 mm

**Color :**



T-GP28R T-GP28B



## T-GP29

**Variant :** One Piece Grip

**Material :** TPR

**Weight :** 100 g / pair

**Length :** 130 mm

**Color :**



T-GP29G T-GP29B

# GEO

Comfort Grip

T-GP27B

Color : Black



## WAVE

Comfort Grip

T-GP11 / 12 / 13



T-GP11

Variant : Double Lock Ring Grip

Material : TPR / Plastic Core / Aluminum Lock Ring

Weight : 105 g / pair

Length : 130 mm

Color :



T-GP11B T-GP11G



T-GP12

Variant : One Piece Grip

Material : TPR

Weight : 110 g / pair

Length : 130 mm

Color :



T-GP12G T-GP12B



T-GP13

Variant : One Piece Grip

Material : TPR

Weight : 110 g / pair

Length : 130 mm

Color :



T-GP13B

## BLADE

Stylish Grip

T-GP30 / 31 / 32



T-GP30

Variant : Double Lock Ring Grip

Material : TPR / Plastic Core / Aluminum Lock Ring

Weight : 101 g / pair

Length : 130 mm

Color :



T-GP30N T-GP30Y



T-GP31

Variant : Single Lock Ring Grip

Material : TPR / Plastic Core / Aluminum Lock Ring

Weight : 88 g / pair

Length : 130 mm

Color :



T-GP31W T-GP31R



T-GP32

Variant : One Piece Grip

Material : TPR

Weight : 107 g / pair

Length : 130 mm

Color :



T-GP31W T-GP31R

## H2O

Stylish Grip  
T-GP17 / 18 / 19



**T-GP17**  
**Variant :** Double Lock Ring Grip  
**Material :** TPR / Plastic Core / Aluminum Lock Ring  
**Weight :** 98 g / pair  
**Length :** 130 mm  
**Color :**



T-GP17R T-GP17W



**T-GP18**  
**Variant :** Single Lock Ring Grip  
**Material :** TPR / Plastic Core / Aluminum Lock Ring  
**Weight :** 94 g / pair  
**Length :** 130 mm  
**Color :**



T-GP18B T-GP18L



**T-GP19**  
**Variant :** One Piece Grip  
**Material :** TPR  
**Weight :** 93 g / pair  
**Length :** 130 mm  
**Color :**



T-GP19G

## TOWER II

Stylish Grip  
T-GP03



**T-GP03**  
**Variant :** One Piece Grip  
**Material :** TPR  
**Weight :** 102 g / pair  
**Length :** 130 mm

## EAGLE EYE

Barend  
T-BE01



**T-BE01**  
**Variant :** Barend  
**Material :** Aluminum  
**Weight :** 156 g / pair  
**Length :** -





01



02



03



04

05



## ROCK

Stylish Grip

T-GP33 / 34 / 35 / 36 / 37 / 38

### 01 x 2

T-GP33 (130mm x 2)

Variant : Double Lock Ring Grip

Material : TPR / Plastic Core / Aluminum Lock Ring

Weight : 97 g / pair

Color :



T-GP33B



T-GP33G

### 02 x 2

T-GP34 (130mm x 2)

Variant : Single Lock Ring Grip

Material : TPR / Plastic Core / Aluminum Lock Ring

Weight : 83 g / pair

Color :



T-GP34G

### 03 x 2

T-GP35 (130mm x 2)

Variant : One – piece grip

Material : TPR

Weight : 98 g / pair

Color :



T-GP35B

### 02 + 04

T-GP36 (130mm + 90mm)

Variant : Single Lock Ring Grip

Material : TPR / Plastic Core / Aluminum Lock Ring

Weight : 72 g / pair

Color :



T-GP36G

### 03 + 05

T-GP37 (130mm + 90mm)

Variant : One Piece Grip

Material : TPR

Weight : 83 g / pair

Color :



T-GP37B

### 04 x 2

T-GP38 (90mm x 2)

Variant : Single Lock Ring Grip

Material : TPR / Plastic Core / Aluminum Lock Ring

Weight : 62 g / pair

Color :



T-GP38G



# DOT

Comfort Grip

T-GP39 / 40 / 41 / 42



## T-GP39

Variant : Double Lock Ring Grip

Material : TPR / Plastic Core / Aluminum Lock Ring

Weight : 89 g / pair

Length : 130 mm

Color :

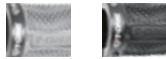

T-GP39B T-GP39G



## T-GP40

Variant : Single Lock Ring Grip

Material : TPR / Plastic Core / Aluminum Lock Ring

Weight : 76 g / pair

Length : 130 mm

Color :



T-GP40B T-GP40G



## T-GP41

Variant : One Piece Grip

Material : TPR

Weight : 91 g / pair

Length : 130 mm

Color :



T-GP41B T-GP41G



## T-GP42

Variant : One Piece Grip

Material : TPR

Weight : 91 g / pair

Length : 130 mm

Color :



T-GP42G T-GP42B



# LAYER

Comfort Grip

T-GP45 / 46 / 47 / 48



## T-GP45

Variant : Double Lock Ring Grip

Material : TPR / Plastic Core / Aluminum Lock Ring

Weight : 111 g / pair

Length : 130 mm

Color :



T-GP45G T-GP45B



## T-GP46

Variant : Single Lock Ring Grip

Material : TPR / Plastic Core / Aluminum Lock Ring

Weight : 104 g / pair

Length : 130 mm

Color :

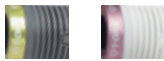

T-GP46G T-GP46W



## T-GP47

Variant : One Piece Grip

Material : TPR

Weight : 116 g / pair

Length : 130 mm

Color :

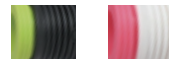

T-GP47B T-GP47W



## T-GP48

Variant : One Piece Grip

Material : TPR

Weight : 116 g / pair

Length : 130 mm

Color :



T-GP48B T-GP48G

# DNA

Stylish Grip

T-GP49 / 50 / 51 / 52



## T-GP49

Variant : Double Lock Ring Grip

Material : TPR / Plastic Core / Aluminum Lock Ring

Weight : 85 g / pair

Length : 130 mm

Color :



T-GP49B T-GP49R



## T-GP50

Variant : Single Lock Ring Grip

Material : TPR / Plastic Core / Aluminum Lock Ring

Weight : 76 g / pair

Length : 130 mm

Color :



T-GP50N T-GP50G



## T-GP51

Variant : One Piece Grip

Material : TPR

Weight : 94 g / pair

Length : 130 mm

Color :



T-GP51B T-GP51G



## T-GP52

Variant : One Piece Grip

Material : TPR

Weight : 94 g / pair

Length : 130 mm

Color :



T-GP52B T-GP52G





## MR.FANTASTIC

Treat Pattern  
T-TP05B  
Color : Black

## MR. FANTASTIC

Organic Pattern  
T-TP04W  
Color : White

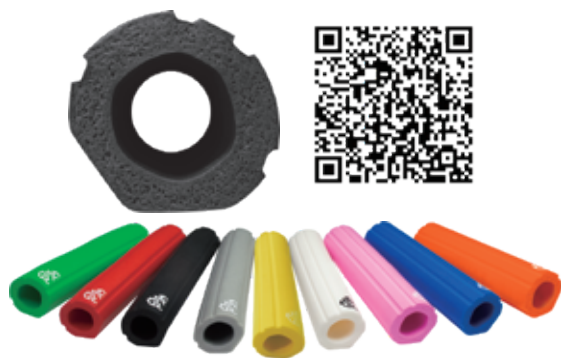

Patented

## DEAJ VU T-GP43

100% silicone grip

Weight : 70 g / pair  
Length : 130 mm  
Color :



Patented

## DEAJ VUX T-GP43X

100% silicone grip

Weight : 70 g / pair  
Length : 130 mm  
Color :



## MR.FANTASTIC T-TP01

100% silicone Bartape

Weight : 208 g / pair  
Length : 2000 mm  
Color :

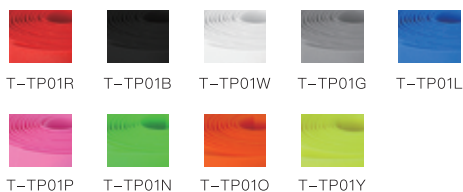



**DNA**

Stylish Grip

T-GP50T

Color : Transparent

**DOT** T-GP40**Comfort Grip**

- Variant :** Single Lock Ring Grip  
**Material :** TPR / Plastic Core / Aluminum Lock Ring  
**Weight :** 76 g / pair  
**Length :** 130 mm  
**Color :** T-GP40T

**DOT** T-GP41**Comfort Grip**

- Variant :** One Piece Grip  
**Material :** TPR  
**Weight :** 91 g / pair  
**Length :** 130 mm  
**Color :** T-GP41T

**DNA** T-GP50**Stylish Grip**

- Variant :** Single Lock Ring Grip  
**Material :** TPR / Plastic Core / Aluminum Lock Ring  
**Weight :** 76 g / pair  
**Length :** 130 mm  
**Color :** T-GP50T





# MIRRORS

WATCHOUT II ▶

T-MR05





◀ VISION II  
T-MR02



# VISION

## T-MR01

**Material :**

Stainless steel lens  
Reinforced plastic housing  
Aluminum stem

**Weight :** 129 g / pair

**Length :** 83 mm x 64 mm

**Handlebar Diameter :**

22.2 mm

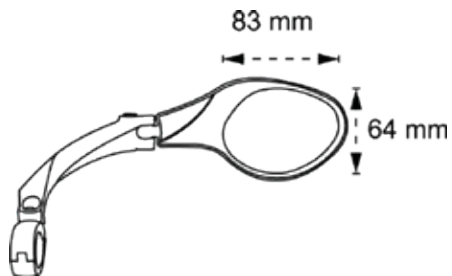

▲ FRONT



▲ BACK

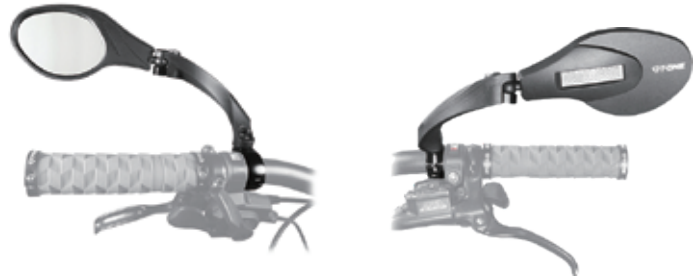

# SPIEGEL

## T-MR08

**Material :**

Stainless steel lens  
Reinforced plastic housing  
Aluminum stem

**Weight :** 130 g / pair

**Length :** 120 mm x 60 mm

**Handlebar Diameter:**

21 – 26 mm

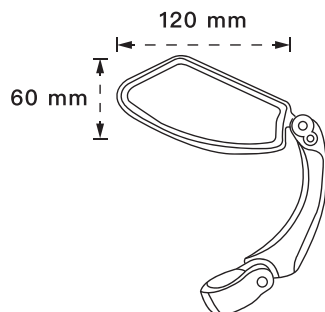

▲ FRONT



▲ BACK



## ◀ VISION II T-MR02

# VISION II

## T-MR02

### Material :

Stainless steel lens  
Reinforced plastic housing  
Aluminum stem

Weight : 73 g / pair

Length : 62 mm

Handlebar Diameter: :  
16 ~ 21 mm

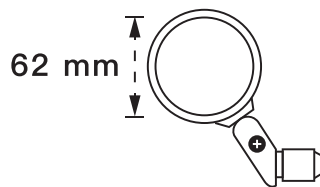



WATCHOUT  
T-MR04

## WATCHOUT

T-MR04

**Material :**

- Convex lens
- ABS housing
- Aluminum stem

**Weight :** 179 g / pair

**Length :** 95 mm

**Handlebar Diameter :** 22.2 mm

**E-Mark:** L E4 000513

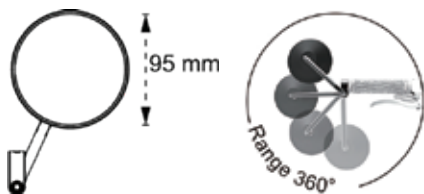

# WATCHOUT II

T-MR05

**Material :**

Convex lens  
ABS housing  
Aluminum stem

**Weight :** 184 g / pair

**Length :** 105 mm x 80 mm

**Handlebar Diameter :** 22.2 mm

**E-Mark:** L E4 000514

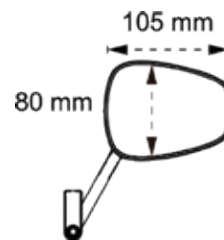

WATCHOUT II

T-MR05







# BAGS

Saddle Bags  
Top Tube Bags  
Pannier Bag



# PELICAN M/S T-BG28M/S

## Expantable Saddle Bag

- Water Resistant
- Reflective

Material : TPU / 600 Denier Nylon

Weight : M 110 g / S 83 g

Size : M 170 x 95 x 110 mm  
S 155 x 75 x 80 mm

Color :



T-BG28MN T-BG28MG



▲ Expandable Capacity



Aillight Hanger

Niversal Velcro Strap

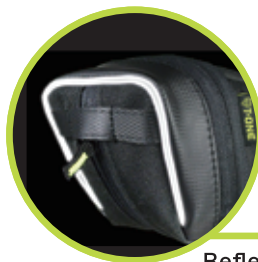

Reflective Stripe



Large Opening





# PAC T-BG30

## Saddle Bag

- Water Resistant
- Reflective

Material : TPU / 600 Denier Nylon

Weight : 83 g

Size : 130 x 70 x 140 mm



# SLIT T-BG31

## Top Tube Bag

- Water Resistant
- Reflective

Material : TPU / 600 Denier Nylon

Weight : 150 g

Size : 210 x 95 x 50 mm

Inside elastic band for  
Fixing riding gears stably.



Easy access for reaching  
Stuffs within a second.



Nonslip fabric on  
the bottom.

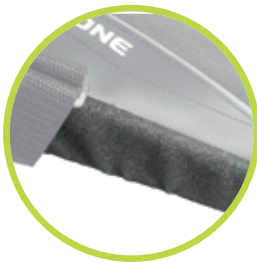

# SINGLE T-BG32

## Smart Phone Top Tube Bag

- Water Resistant
- Reflective

Material : TPU / 600 Denier Nylon

Weight : 130 g

Size : 175 x 90 x 80 mm

1. Sensitive touching screen.
2. Screen size up to 5 inches.



Nonslip fabric on the bottom.

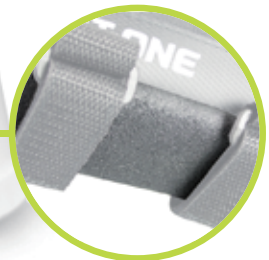

Rubber cable exit grommet facing rider.





# VOYAGE T-BG10

## Pannier Bag

- Water Resistant
- Reflective

Material : TPU / 600 Denier Nylon

Weight : 1000 g

Size : 275 x 400 x 110 mm



# SINGLE 6 T-BG33

## Smart Phone Top Tube Bag

- Water Resistant

Material : 600 Denier Nylon

Weight : 107 g

Size : 180 x 100 x 90 mm





**VOYAGE**

Pannier Bag  
T-BG10







# TOOLS





## SINGLE SPORT

T-FT03

Weight : 100 g

Allen Key : 3 / 4 / 5 / 6 / 8 mm



# N-Tool+

T-ST02

Material :

Aluminum Handle / Steel Tools

Weight : 53 g

Size : 110 x 90 x 12 mm

HEX : 4 / 5 / 6 mm

Star Shaped : T25



# CUBIC 8

T-FT04

Material :

Aluminum Handle / Steel Tools

Weight : 62 g

Size : 73 x 29 x 7 mm

HEX :

2 / 2.5 / 3 / 4 / 5 / 6 mm

Star Shaped : T25 / T15 – SL5

## SINGLE SPORT

T-FT03

Weight : 100 g

Allen Key : 3 / 4 / 5 / 6 / 8 mm



## CUBIC 6

T-FT05

Material :  
Aluminum Handle / Steel Tools

Weight : 54 g

Size : 79 x 28 x 7 mm

HEX : 3 / 4 / 5 / 6 mm

Star Shaped : T25 – SL5



# TRI 11

T-FT07

Material :

Aluminum Handle / Steel Tools

Weight : 93 g

Size : 73 x 35 x 15 mm

HEX : 2 / 2.5 / 3 / 4 / 5 / 6 / 8 mm

Star Shaped : T25 / T15 – SL5 – PH2



Patented

# TRI 13



T-FT06

Material :

Aluminum Handle / Steel Tools

Weight : 122 g

Size : 73 x 35.5 x 15 mm

HEX :

2 / 2.5 / 3 / 4 / 5 / 6 / 8 mm

Star Shaped :

T25 / T15 – SL5 – PH1 / PH2

Chain Breaker :

9 / 10 / 11 speed

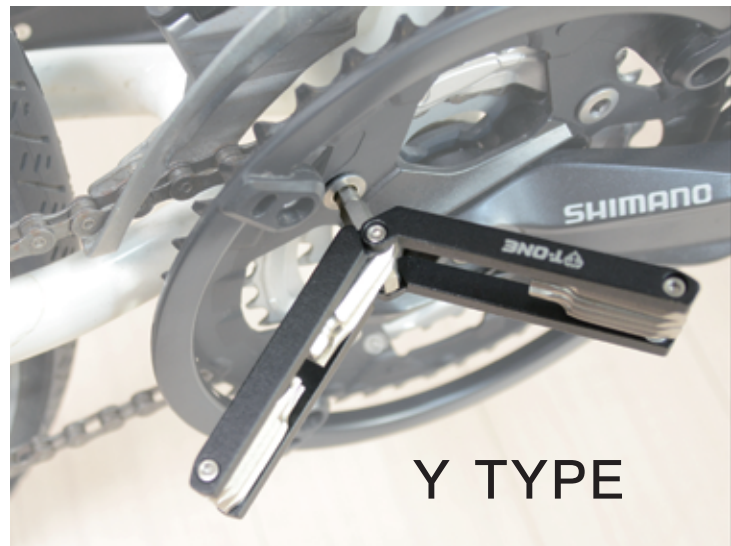
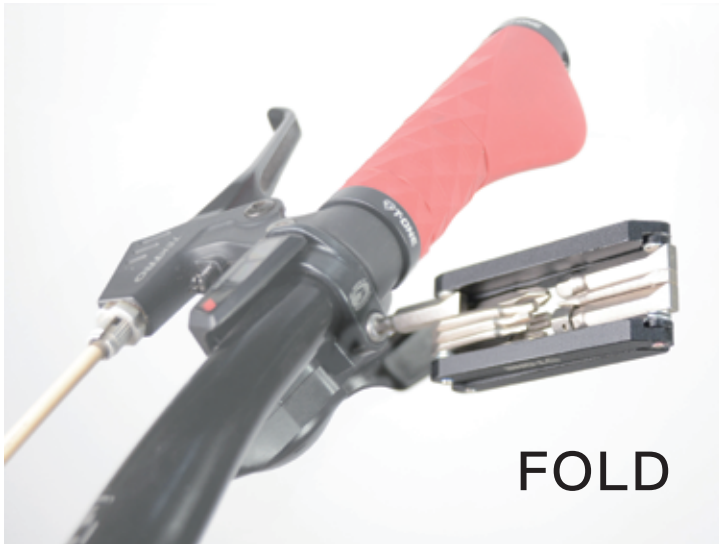







A person is riding a bicycle on a blue track in a park. The track is a vibrant blue color and curves to the right. The rider's hand is visible on the handlebar, which has a brown grip. The background features green trees, a grassy embankment, and several white and blue light poles under a clear blue sky with a few clouds. The overall scene is bright and sunny.

# MOUNTING SYSTEM

Front / Stem

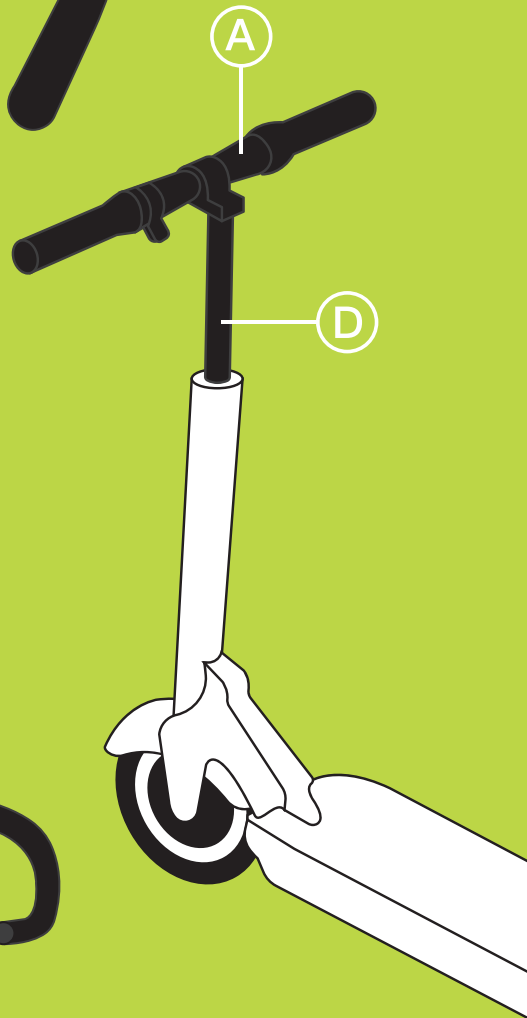
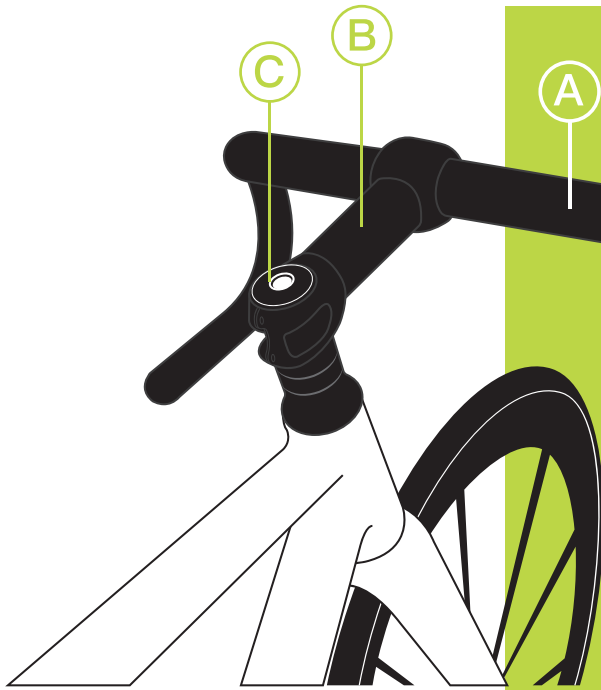

A B  
D E**SHIFT**

(T-HW07)

**Bar bore size:**

35 / 31.8 / 25.4 / 22.2 mm



A

**PYLON**

(T-HW01)

**Handlebar Diameter:**

22.2 mm

**TALONG II**

(T-HW05X)

**Handlebar Diameter:**

31.8 mm / 25.4 mm



C

**PACKMAN PLUS**

(T-HW04)

**Suitable for threadless stem :**

11/8" threadless headset

**UNO**

(T-HW06)

**Suitable for threadless stem :**

11/8" threadless headset

**PACKMAN**

(T-HW02)

**Suitable for threadless stem :**

11/8" threadless headset



D E

**QUI-CK**

(T-HW03)

**Suitable for threadless stem :**

11/8" threadless headset





# TALONG II T-HW05X

## Handlebar cleat

- Switchable for 2 different sizes
- Compatible with e-bike displays, e.g. Bosch

Material : Aluminum Clamp / Nylon + Fiber

Weight : 138 g

Handlebar Diameter: 31.8 mm / 25.4 mm

Max. : 5 kg



Handlebar Diameter : 31.8 mm / 25.4 mm

T-HW05X + T-BG27

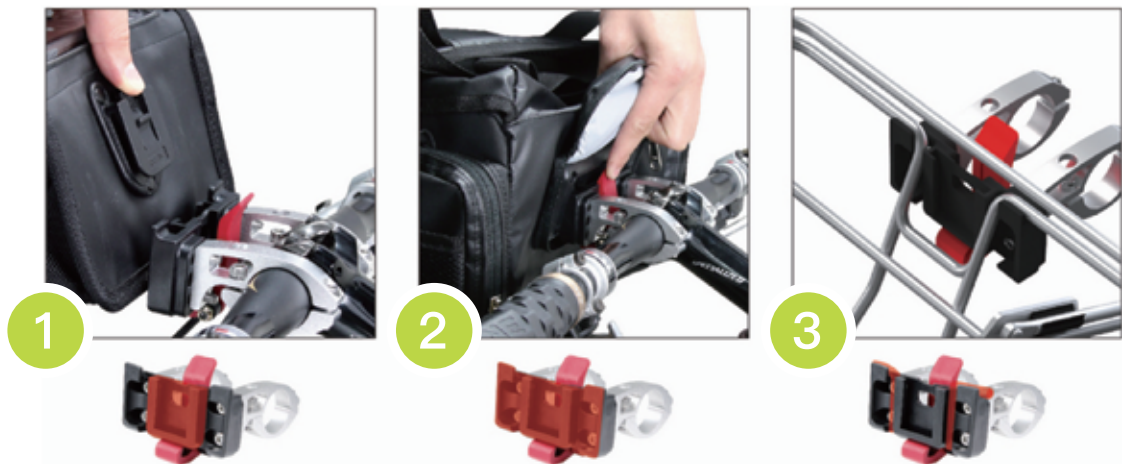

# QUAN T-BK02

## Front cleat bag

**Material :** Aluminum Frame / PP Mount

**Weight :** 800 g

**Size:** 250 x 330 x 250 mm

**Max. :** 5 kg



T-HW05X (TALONG II)



1



2



3

T-HW05 + T-BK02 (QUAN)

1



2



3



T-HW05 + T-BG22 (TROOPER)

1



2



3







# TROOPER T-BG22

Front cleat bag

- Water Resistant
- Reflective

Material : TPU / Nylon

Weight : 500 g

Size: 270 x 150 x 190 mm



T-HW05X (TALONG II)





# PYLON T-HW01

## Handlebar cleat

- Handlebar Diameter: 22.2 mm

Material : Aluminum Clamp / Nylon + Fiber

Weight : 50 g

Bar bore size: 22.2 mm

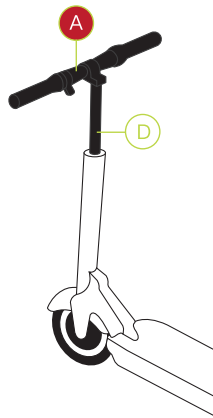
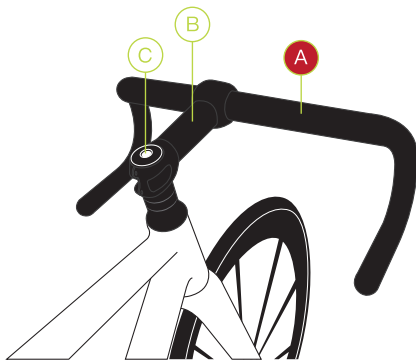

Handlebar Diameter: 22.2 mm

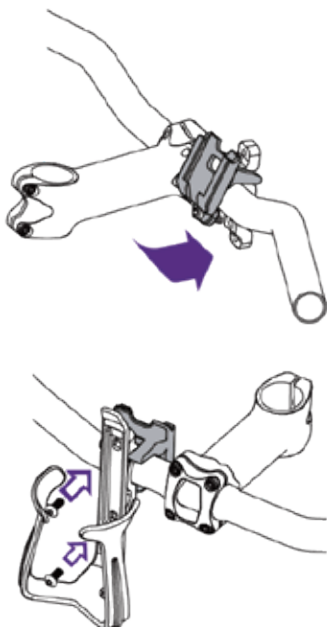

# PACKMAN T-HW02

## Stem cleat

Material : Nylon+Fiber

Weight : 28 g

Suitable for threadless stem : 11/8" threadless headset

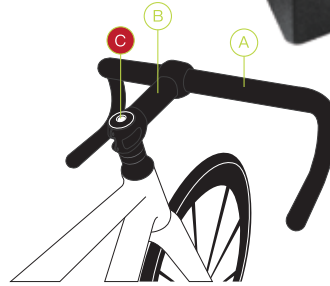
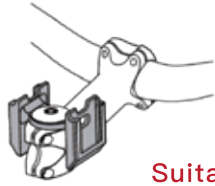
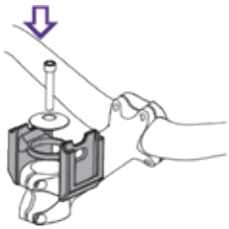

Suitable for threadless stem : 11/8"



# PACKMAN PLUS T-HW04

## Stem cleat

- Angle Adjustable

Material : Nylon+Fiber / Stainless Steel

Weight : 24 g

Suitable for threadless stem : 11/8" threadless headset

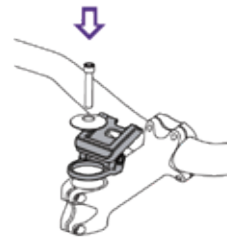
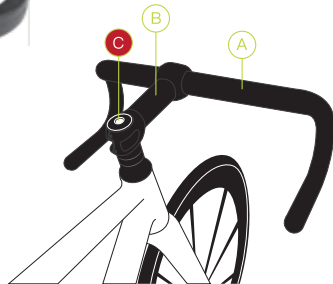

Suitable for threadless stem : 11/8"



# QUI-CK T-HW03

## Stem cleat

- The two-sided mount places two different bags.

Material : Nylon+Fiber

Weight : 43 g

Suitable for threadless stem :  
11/8" threadless headset



Suitable for threadless stem : 11/8"

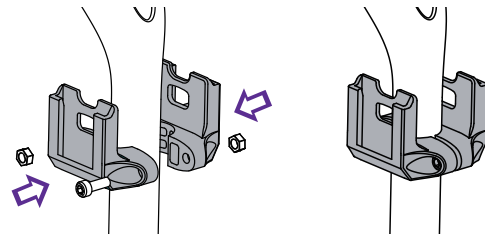

## QUI-CK

T-HW03

Stem cleat



T-ONE 65

MOUNTING SYSTEM

**UNO**  
T-HW06  
Handlebar cleat





## UNO T-HW06

### Handlebar cleat

Material : Nylon+Fiber

Weight : 15 g

Suitable for threadless stem :  
1 1/8" threadless headset

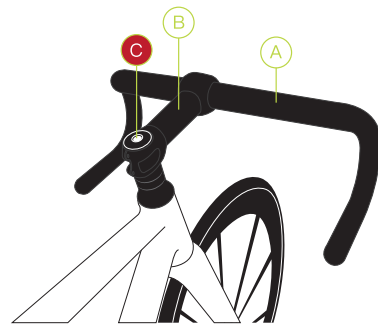

Suitable for threadless stem : 1 1/8"



## NARO T-BG16

### Stem cleat bag

- Water Resistant

Material : TPU

Weight : 76 g

Size: 90 x 140 x 40 mm



T-HW02 (PACKMAN) T-HW03(QUI-CK) T-HW06(UNO)

Patented

# SHIFT T-HW07

## Adjustable cleat

Turn freely to desired position, 8 positions allowed. (stops every 45°)

- Angle Adjustable

Material : Nylon+Fiber / Stainless Steel

Weight : 55 g

Bar bore size:

35 / 31.8 / 25.4 / 22.2 mm

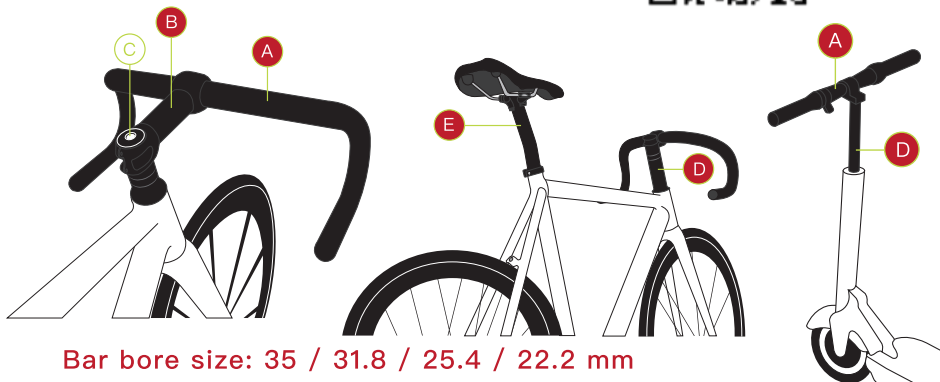

Bar bore size: 35 / 31.8 / 25.4 / 22.2 mm

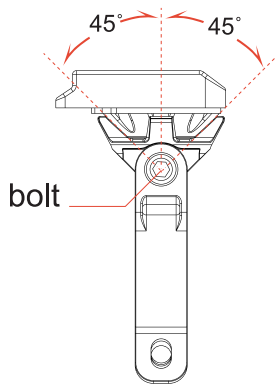

Turn freely to desired position, 8 positions allowed. (stops every 45°)

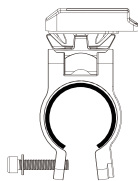
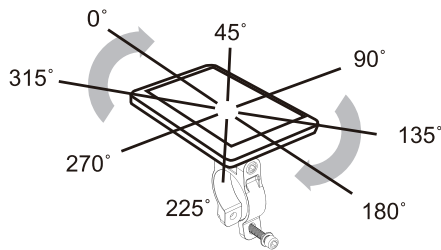

35mm

1mm rubber.

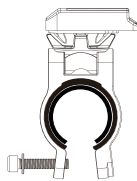

31.8mm

One plastic shim + 1mm rubber.

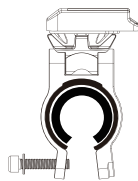

25.4mm

One plastic shim + 2mm rubber.

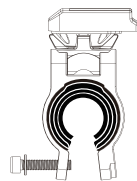

22.2mm

Two plastic shim + 1mm rubber.





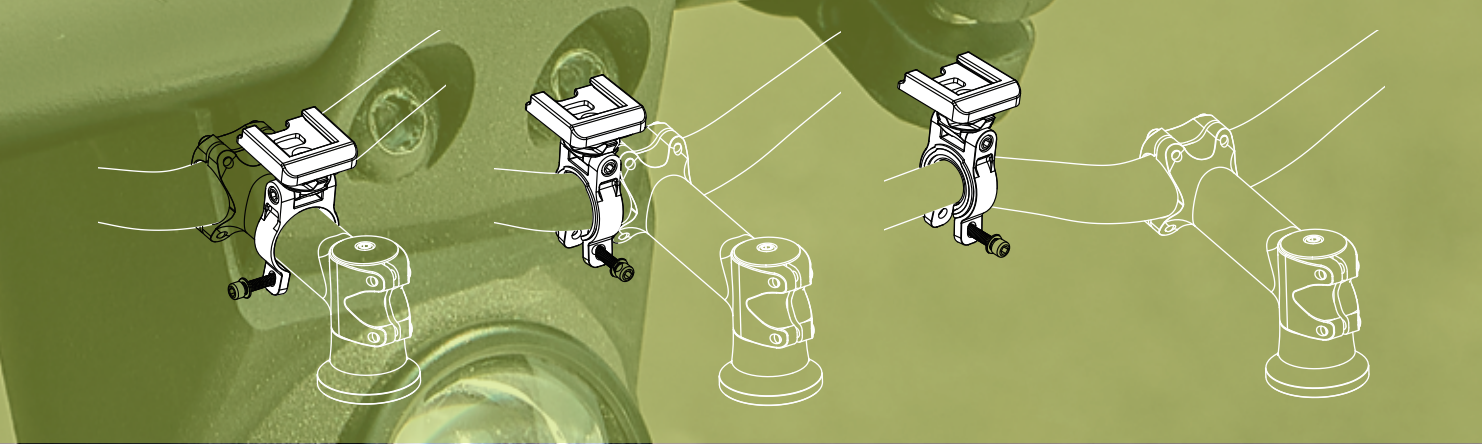





## POKEMON + T-BG25

### Smart phone cleat bag

- Water Resistant

Material : TPU / Nylon

Weight : 59 g

Size: 176 x 109 x 12 mm

Applicable mobile phone size : 5.5" ~ 6"



T-HW01 (PYLON)



T-HW07 (SHIFT)



T-HW04 (PACKMAN PLUS)

## AKULA + T-BG26

### Waterproof Smart phone cleat bag

- Waterproof

Material : PU / TPU

Weight : 61 g

Size: 170 x 112 x 12 mm

Applicable mobile phone size : iphone6 plus or 5.5"



T-HW01 (PYLON)



T-HW07 (SHIFT)



T-HW04 (PACKMAN PLUS)





T-ONE



**POKEMON +**

T-BG25

Smart phone cleat bag





## E. Wiener Bike Parts GmbH

📍 Max-Planck-Strasse 8, 97526 Sennfeld, Germany

✉ E-mail : info@bike-parts.de

☎ Tel : +49 (0)9721 65018762

📠 Fax : +49 (0)9721 650197

🌐 Web : www.bike-parts.de

- Germany
- Netherlands
- Belgium
- Luxembourg
- Italy
- Czech Republic
- Poland
- Denmark
- Cyprus
- Sweden
- Portugal
- Croatia
- Slovakia
- Romania
- Greece

## Zweirad Einkaufs-Genossenschaft eG(ZEG)

📍 Longericher Str. 2, 50739 Köln

☎ Tel : +49 (0)221 17959-0

📠 Fax : +49 (0)221 17959-31

🌐 Web : www.zeg.com

- Germany

## PROFIL BICYCLES CZ

📍 Hněvotín 31, 783 47 Hněvotín

✉ objednavky@profil-bicycles.cz

☎ Tel : +420 585 754 440

🌐 Web : www.profilshop.cz.

- Czech Republic

## BLUE LEPORTS CO., LTD. (주)블루레포트츠

📍 #712-9 JIWOL, CHOWOL, GWANGJU, KYOUNGKI, KOREA 12728

경기도 광주시 초월읍 지월리 712-9

☎ Tel : 82-31-793-4037/4038

📠 Fax : 82-31-793-4039

🌐 Web : www.blueleports.com

- Korea

## CYCLE SPORT CO., LTD.

📍 167Luang Road,Pomprab,Bangkok 10100, Thailand

✉ E-mail : info@cyclesport-th.com

☎ Tel : +66(0)26217224

🌐 Web : www.cyclesport-th.com

- Thailand

T-ONE



**TFC**

**TRI**  
Multi-functional Folding Tool

**DESIGN**  
T-ONE R&D Corp.  
Eric Wang

**MANUFACTURER**  
T-ONE R&D Corp.

**Organizers**  
UNTA

**Sponsor**  
Product Design Award

802 01048



**if**

**product design award**

**2010**

**Anyway**  
Trinkflaschen Halter  
Bottle cage

**Design**  
T-ONE R&D Corp.  
Jeremy Hsu  
Taiwan

**Manufacturer**  
T-ONE R&D Corp.  
Taiwan

7-1-1010



To Be Continued.

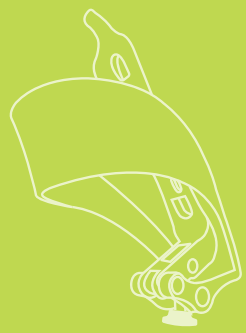



[www.T-one Design.com](http://www.T-one Design.com)



昨年國際股份有限公司

**T-ONE R&D CORP.**

TEL :+886-4-23592618

FAX :+886-4-23592616

E-mail :[T-one@T-oneDesign.com](mailto:T-one@T-oneDesign.com)